

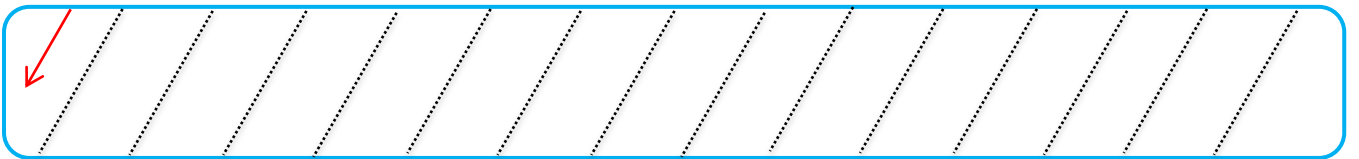

"K, k" Sesi Hazırlık Çalışmaları

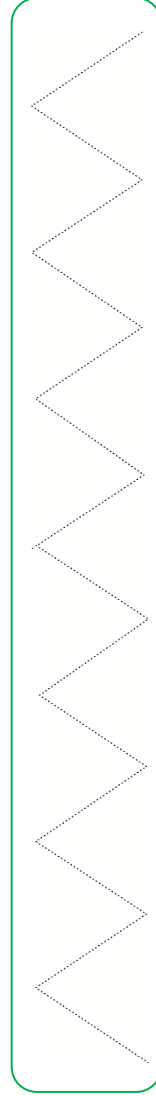

"K, k" Sesi Hazırlık Çalışmaları

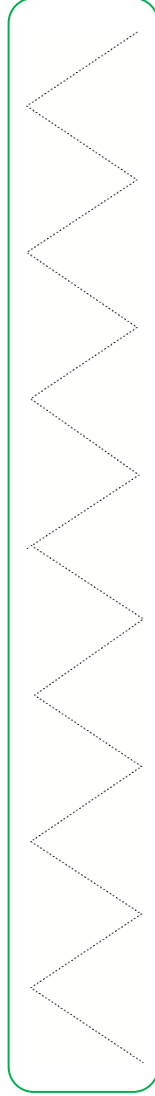
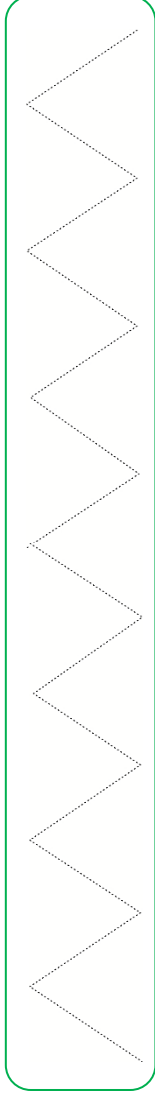
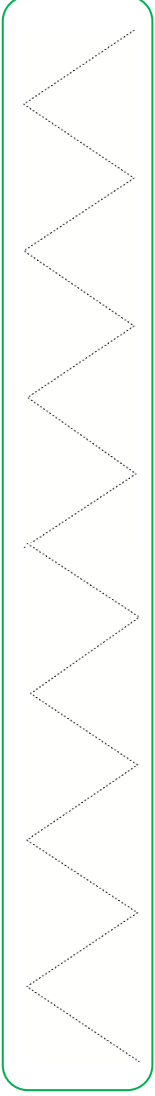
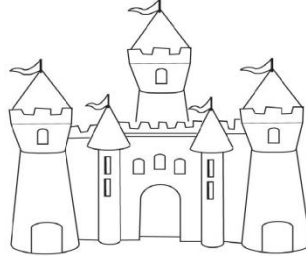

kale



kuş

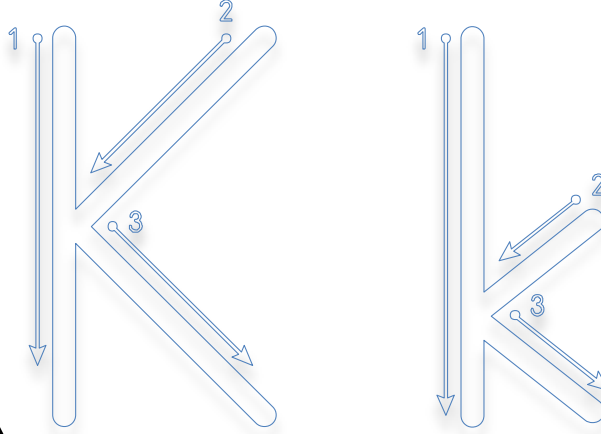

kulak

kiraz

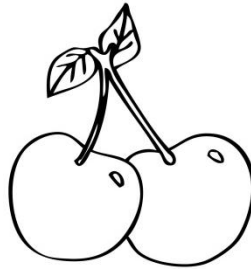

1. SINIF

Aşağıda verilen ses ve resimleri eşleştirelim.



Başında – Ortasında - Sonunda





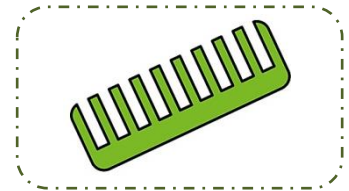





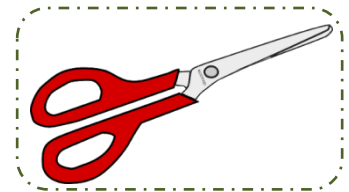



"K, k," Sesini Yazıyorum

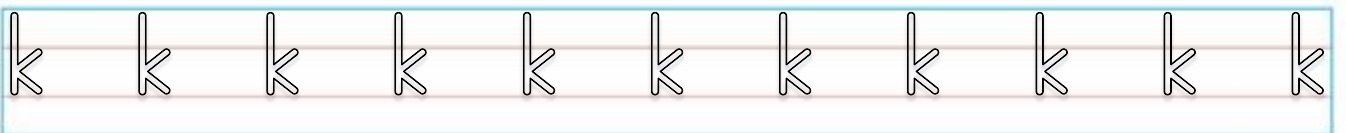
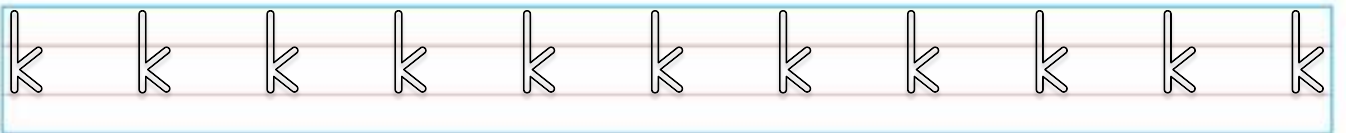
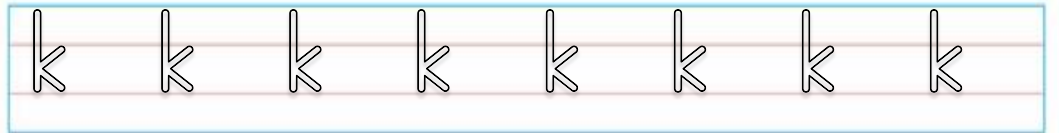
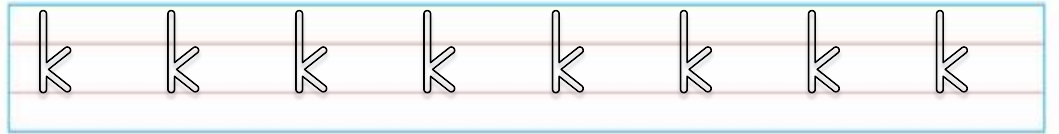
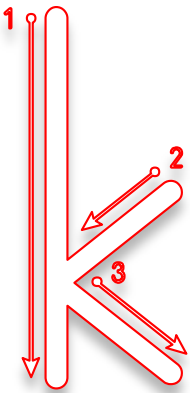
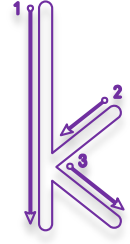
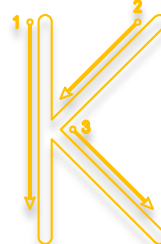
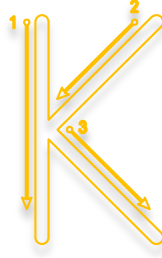
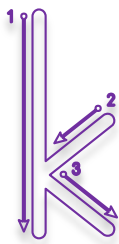
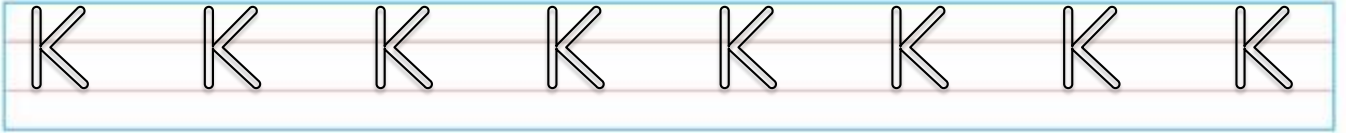
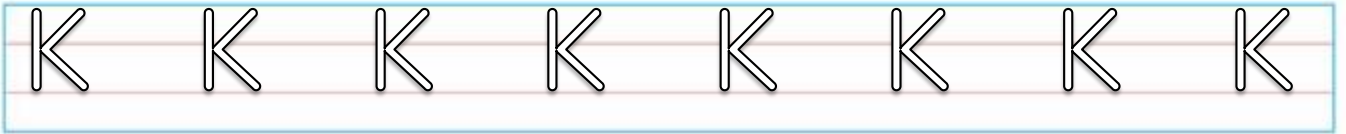
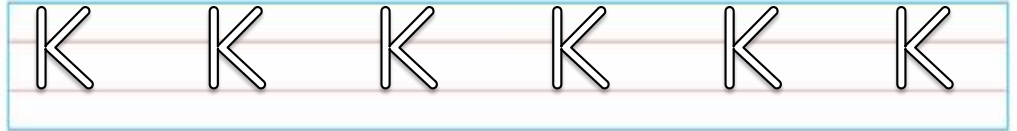
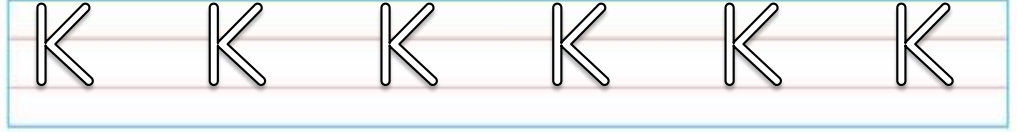
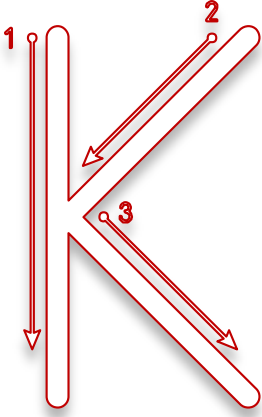



"K, k" Sesini Yazıyorum

K K K K K K K K K K K

K K K K K K K K K K K

K K K K K K K K K K K

K K K K K K K K K K K K K

K K K K K K K K K K K K K

K K K K K K K K K K K K K

k k k k k k k k k k

k k k k k k k k k k

k k k k k k k k k k

k k k k k k k k k k k k k

k k k k k k k k k k k k k

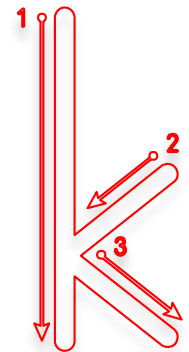
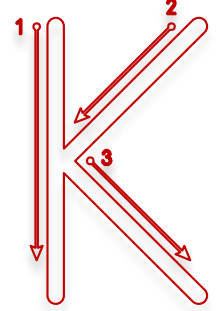

1. SINIF

Üzerinde **k** sesi olan kirazları **kırmızıya** diğerlerini istediğin renge boya.

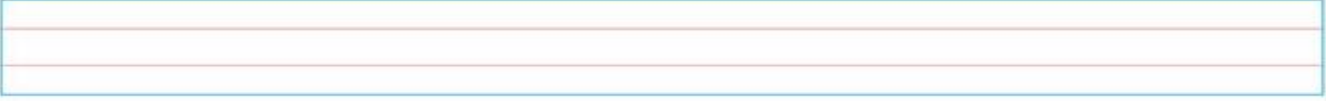
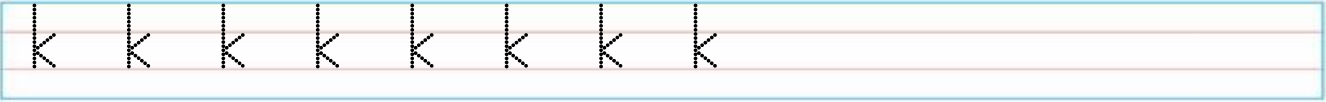
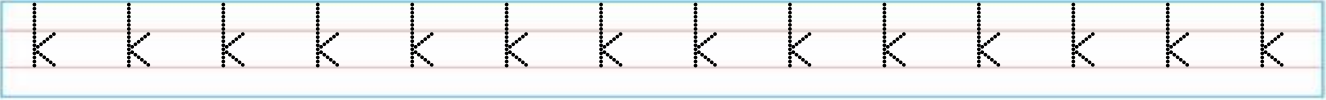
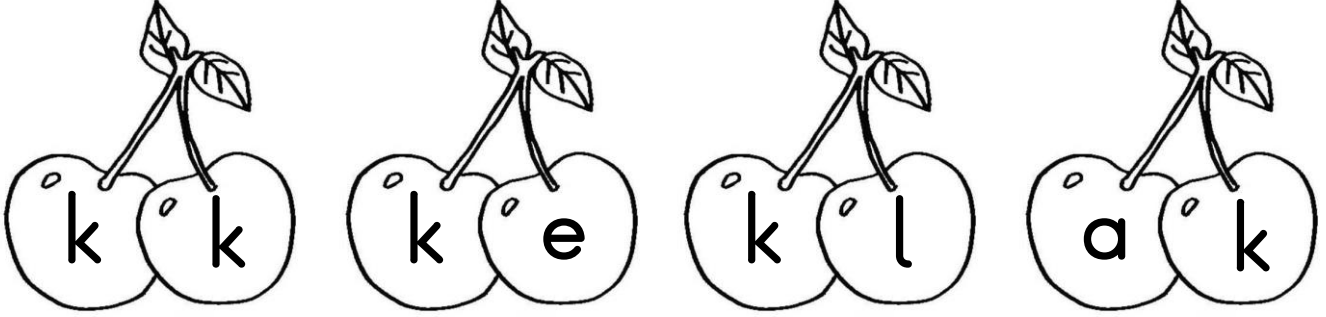



e

ek

ek ek ek ek ek ek ek

k

ek ek ek

ek ek

ek

k

ke

ke ke ke ke ke ke ke

e

ke ke ke

ke ke

ke

a

ak

ak ak ak ak ak ak ak

k

ak ak ak

ak ak



k



ka

ka ka ka ka ka ka ka

a



ka ka

ka

ke



kel

kel kel kel kel kel kel

l



kel kel

kel

ka



kal

kal kal kal kal kal kal

l



kal kal

kal

ke



kek

kek kek kek kek kek kek

k



kek kek

kek



le
k → lek

lek lek lek lek lek lek

lek lek

lek

la
k → lak

lak lak lak lak lak lak

lak lak

lak

ka
le → kale



kale kale kale kale kale

kale kale

kale

e
lek → elek

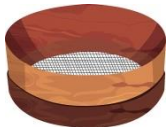

elek elek elek elek elek

elek elek

elek



ke

lek

kelek

kelek kelek kelek kelek

kelek kelek

kelek

le

ke

leke



leke leke leke leke leke

leke leke

leke

ek

le

ekle



ekle ekle ekle ekle ekle

ekle ekle

ekle

kal

k

kalk



kalk kalk kalk kalk kalk

kalk kalk

kalk



Öğrendiklerimizi Tekrar Edelim

ek ek

ke ke

ak ak

ka ka

kel kel

kal kal

kek kek

kale

lak lak

lek lek

elek

kelek



leke

ekle

kalk

Okuyorum, Anlıyorum, Yazıyorum



Lale kek al.

Kalk Ela kalk.



Ela lale ek.

Lale elek al.





Ek

Lale ek.

Ela lale ek.

Ela al lale ek.

Ela lale ek.

Lale ek.

Ek

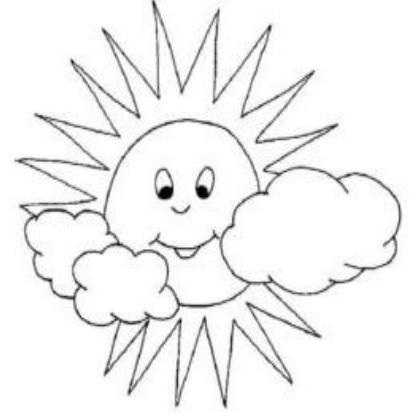

Blank writing line for the word 'Ek'.

Blank writing line for the sentence 'Lale ek.'

Blank writing line for the sentence 'Ela lale ek.'

Blank writing line for the sentence 'Ela al lale ek.'

Blank writing line for the sentence 'Ela lale ek.'

Blank writing line for the sentence 'Lale ek.'

Blank writing line for the word 'Ek'.