

➔ Üzerinden gidelim, tamamlayalım

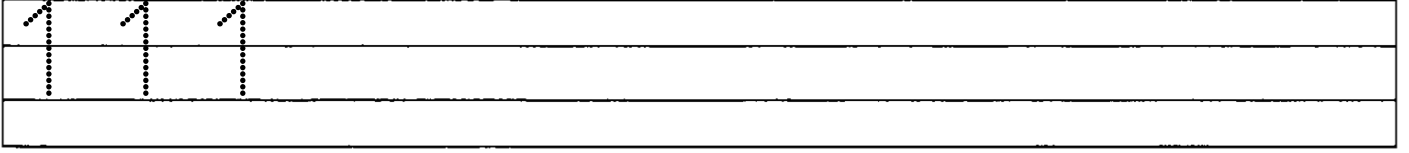

➔ Aşağıdaki varlıklardan 1'er tane olanları boyayalım.

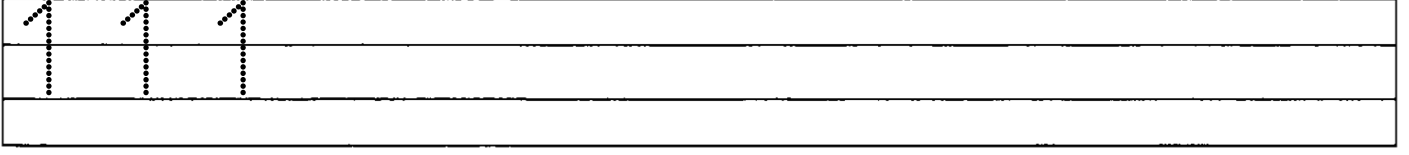

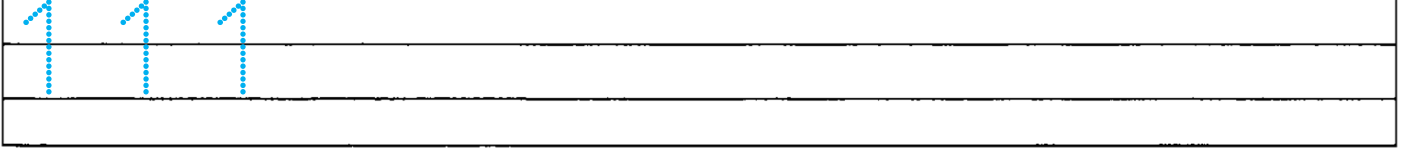
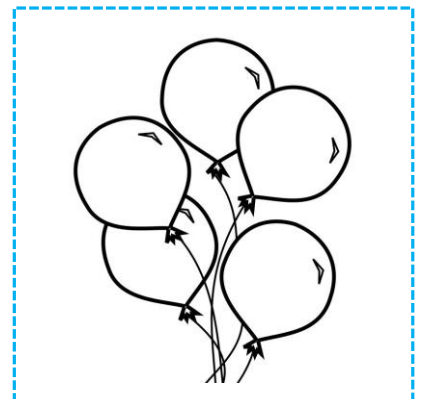
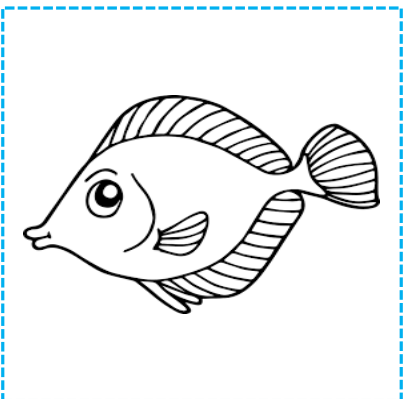
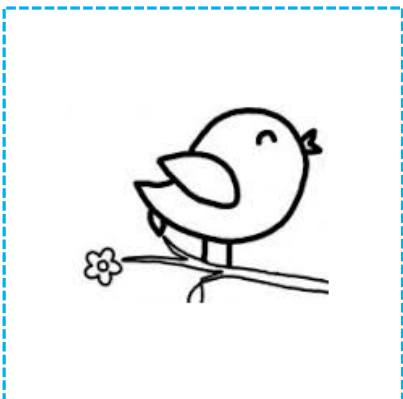
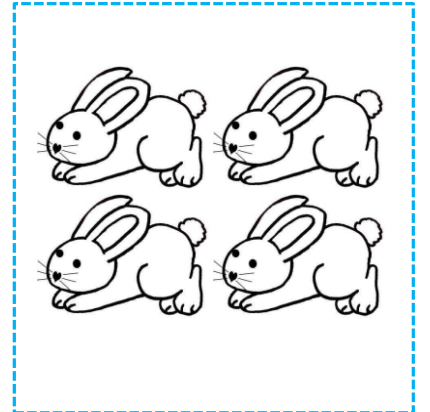
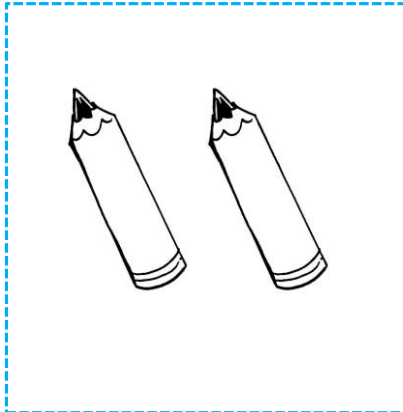
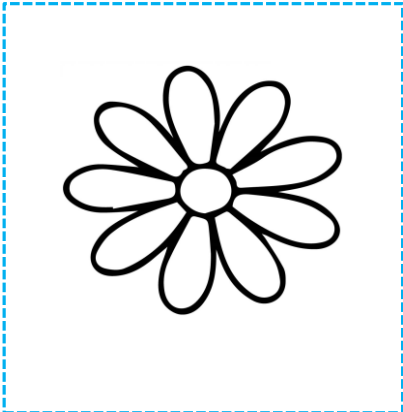
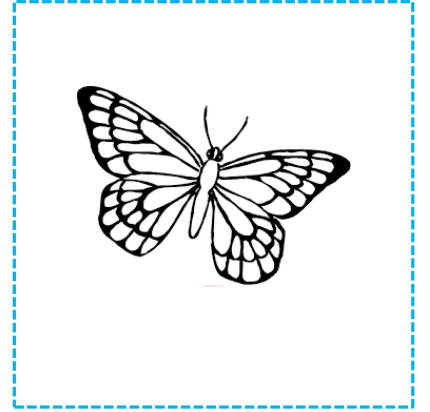
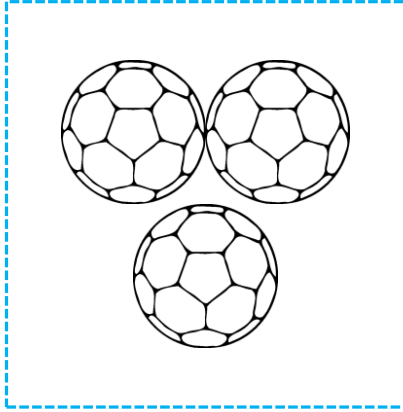
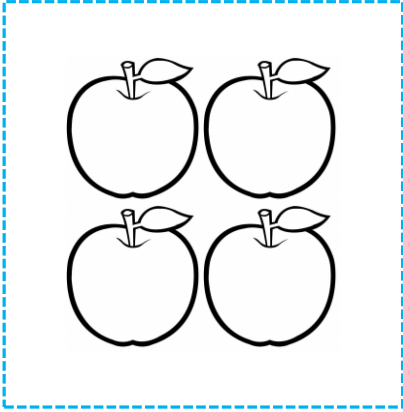
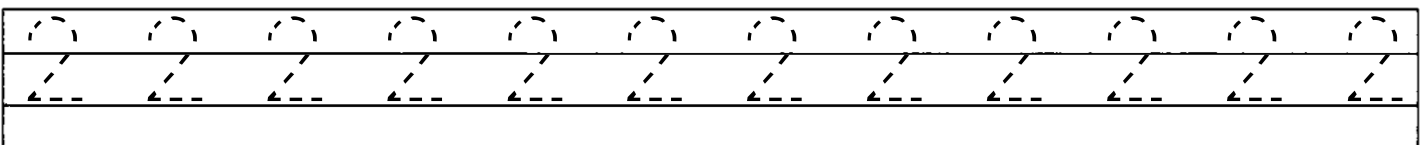
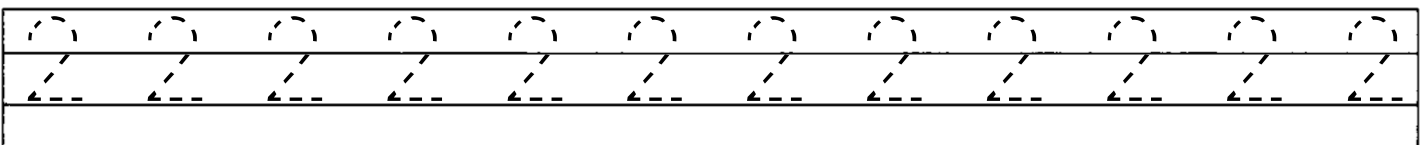
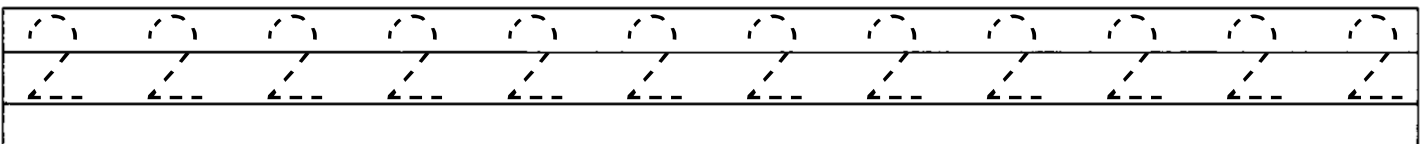
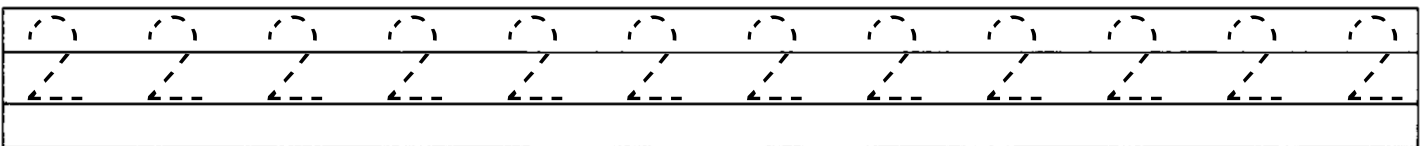
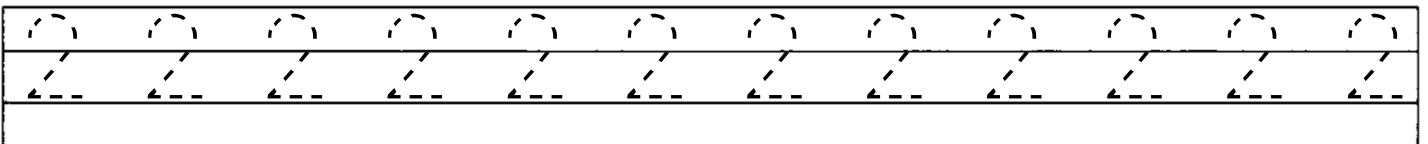
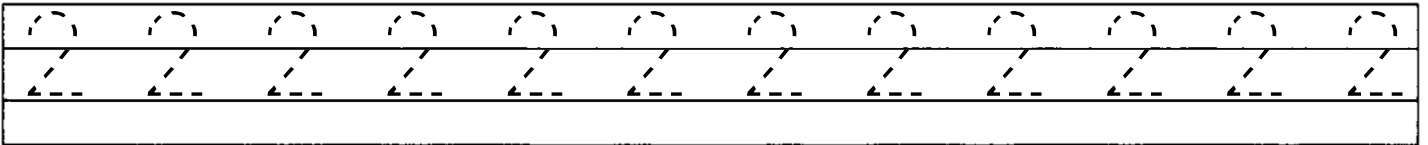
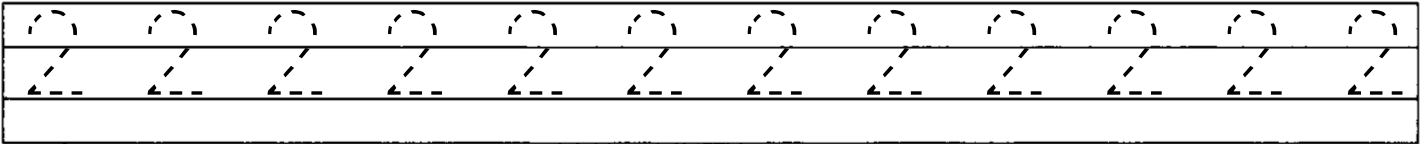
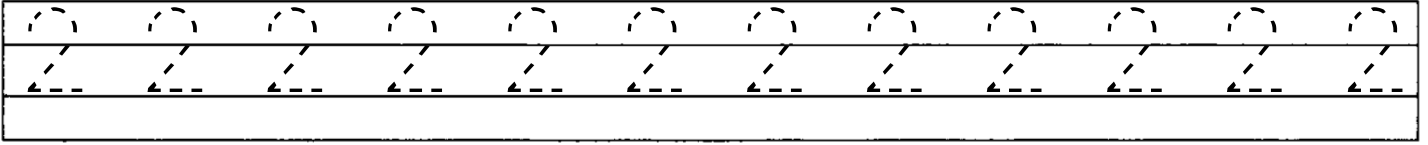
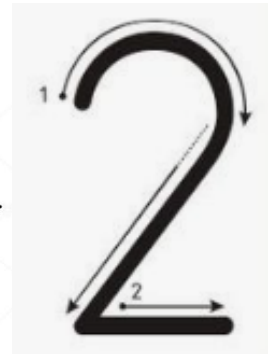

➔ Üzerinden gidelim, tamamlayalım.

2 2 2

2 2

2

➔ Aşağıdaki varlıklardan 2' şer tane olanları boyayalım.

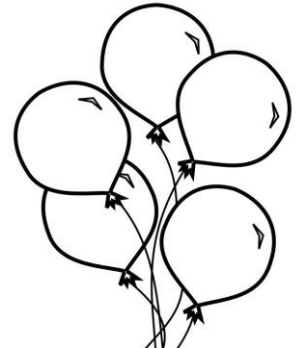
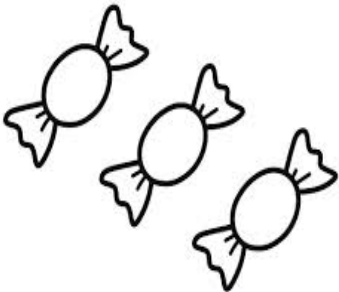
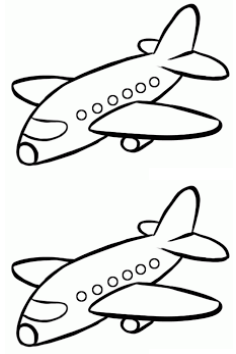
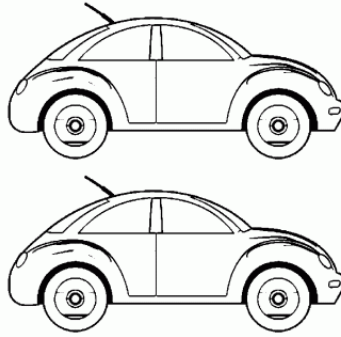
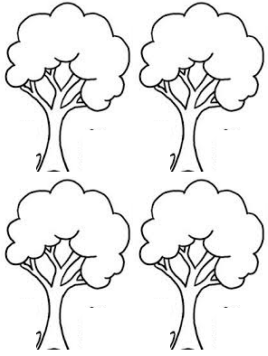
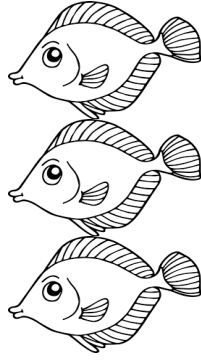
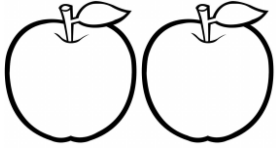

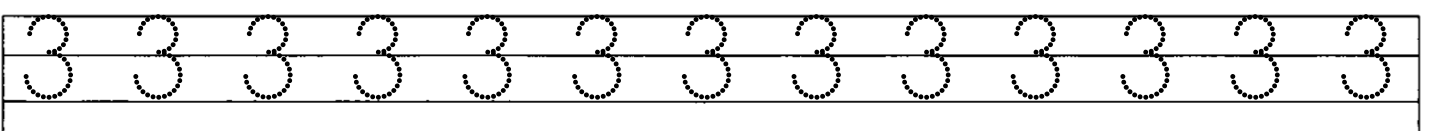
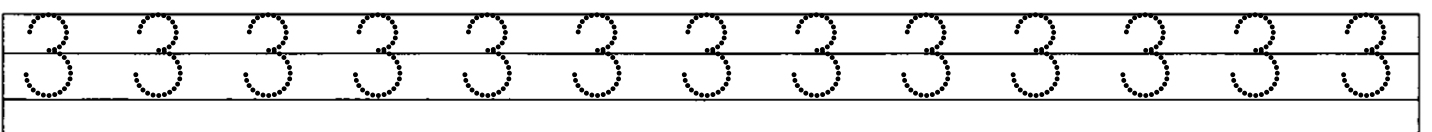
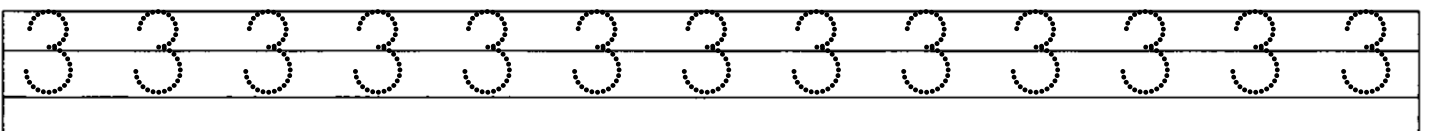
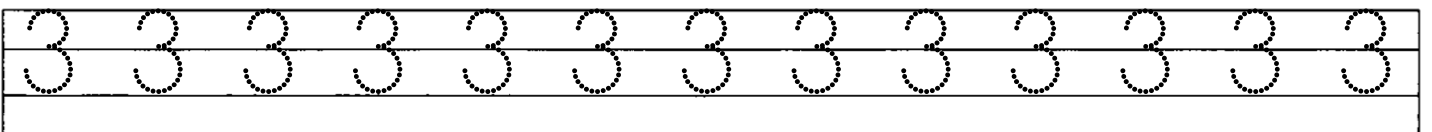
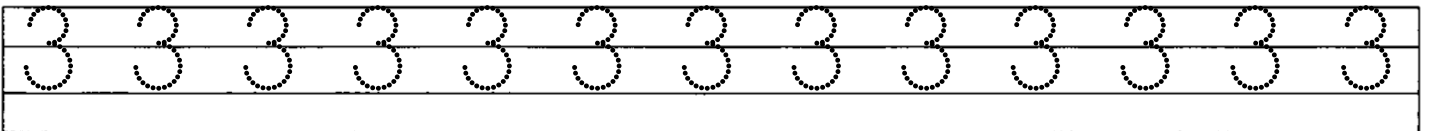
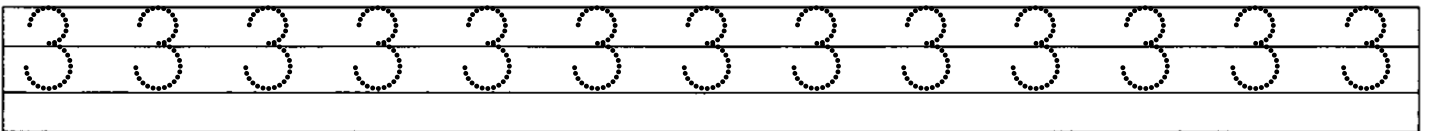
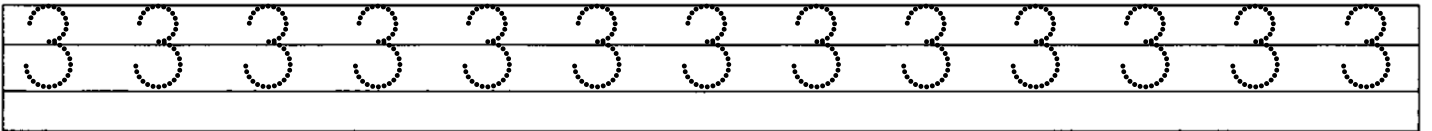
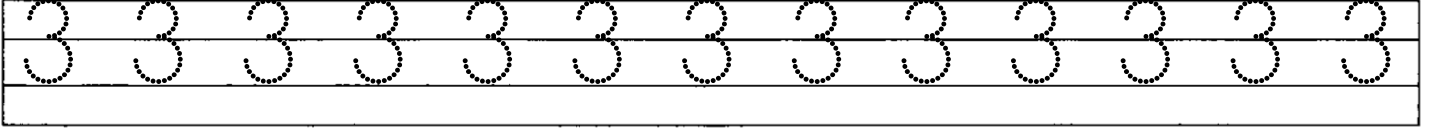
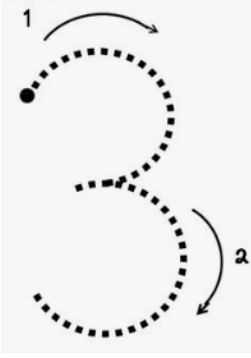

➔ Üzerinden gidelim, tamamlayalım.

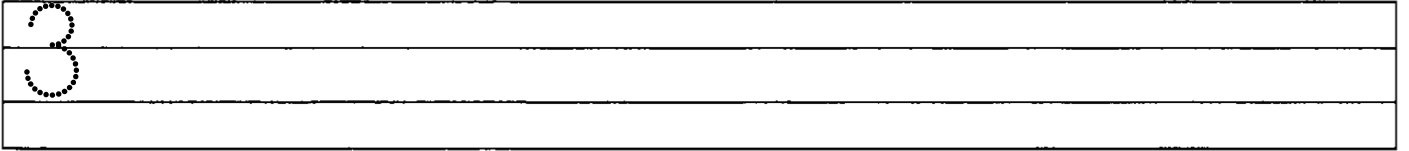
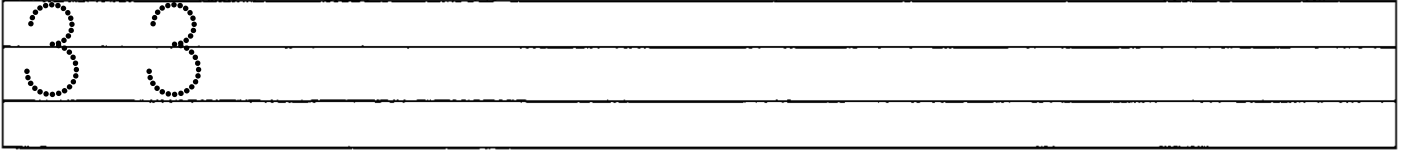
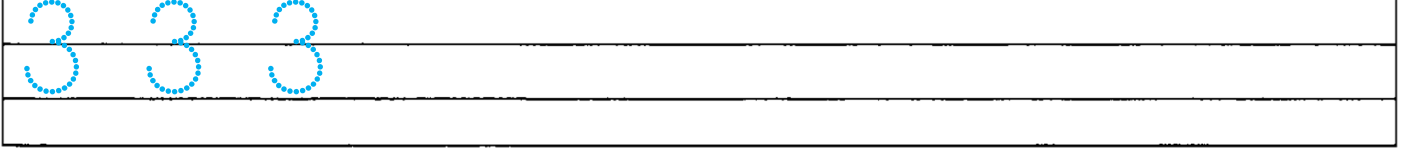

➔ Aşağıdaki varlıklardan 3' er tane olanları boyayalım.

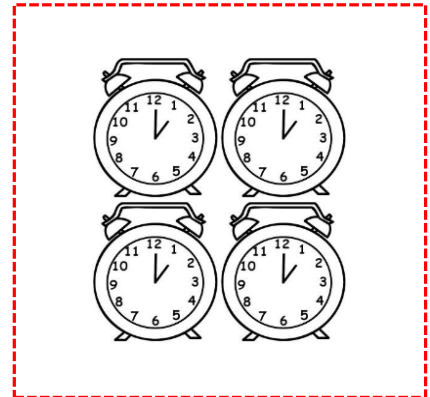
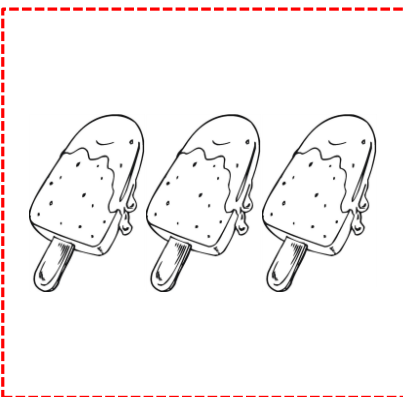
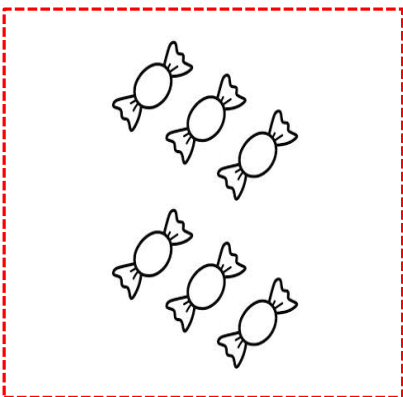
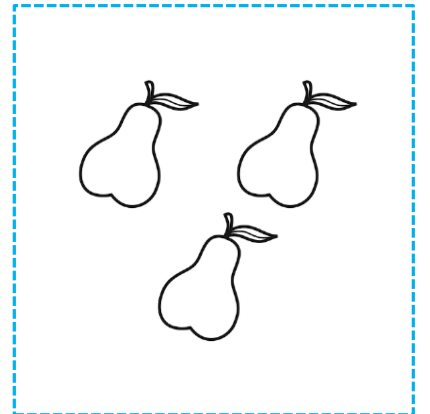
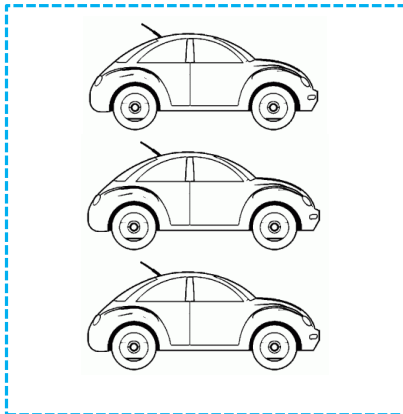
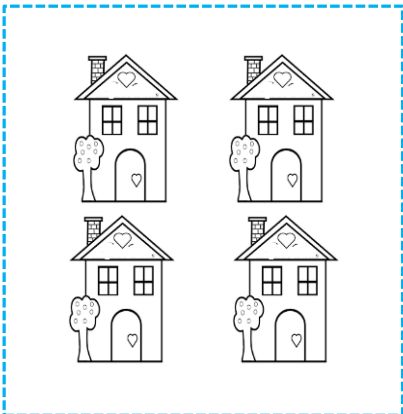
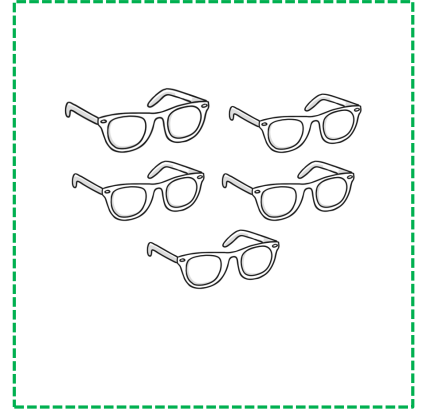
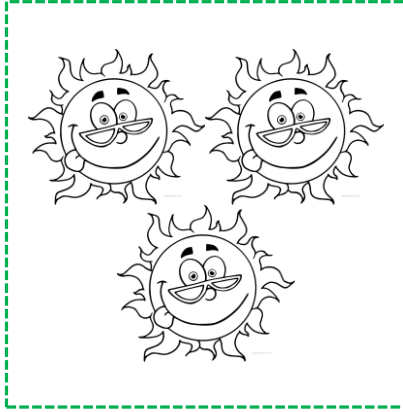
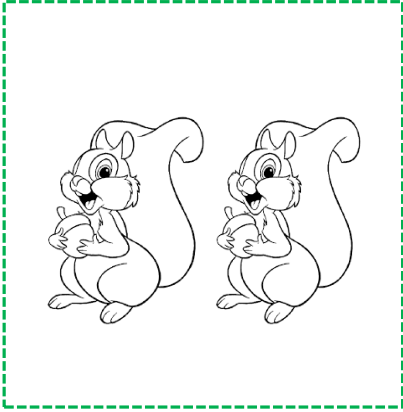

# Tamamlayalım.

1 1 1

1 1 1

1 1 1

2 2 2

2 2 2

2 2 2

3 3 3

3 3 3

3 3 3

3 3 3

➔ Üzerinden gidelim, tamamlayalım.

1

2

3

4

5

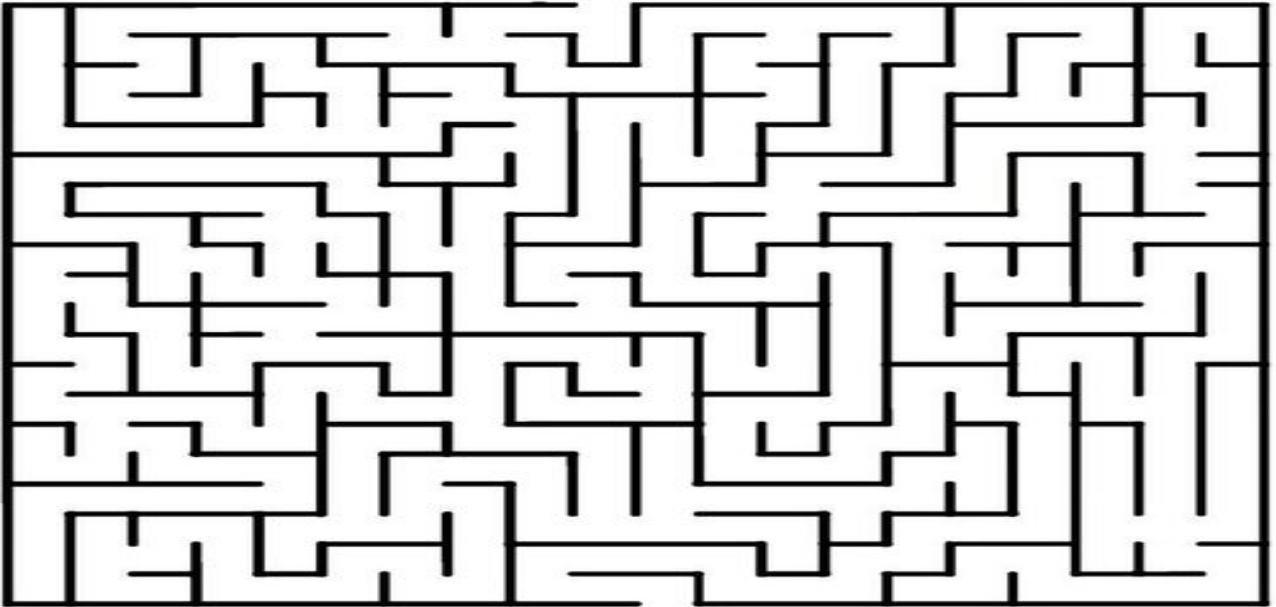



Boyayalım...

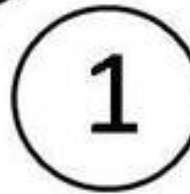
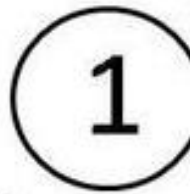
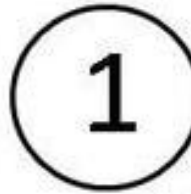
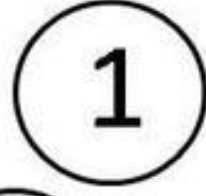



Boyayalım.

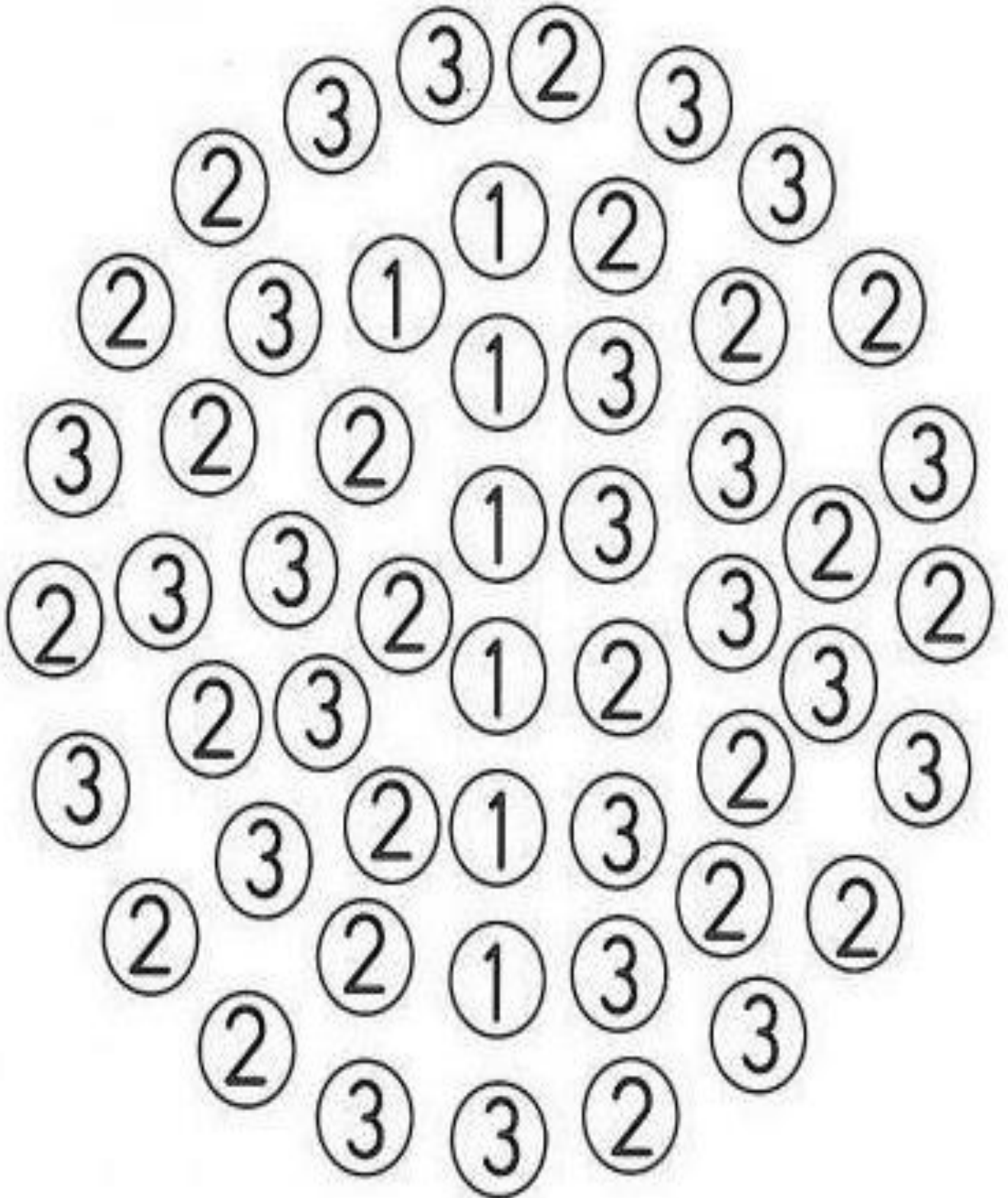

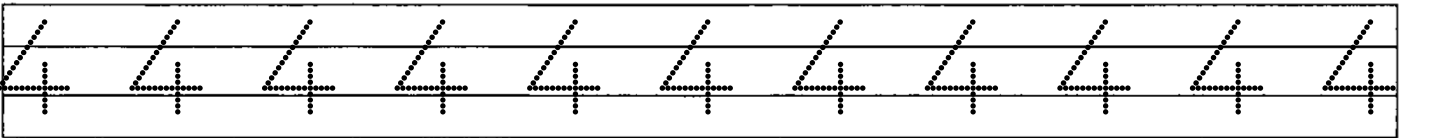
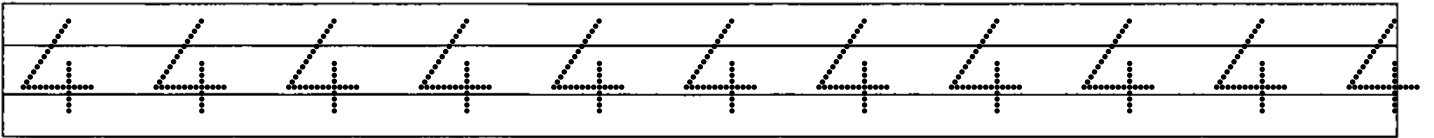
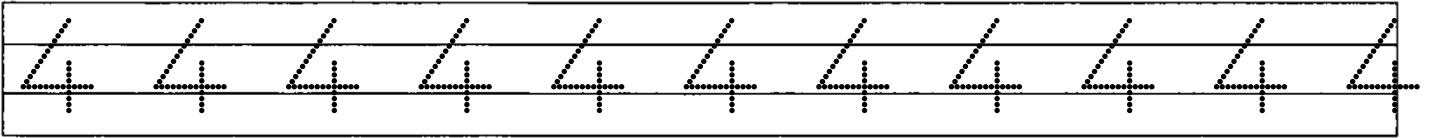
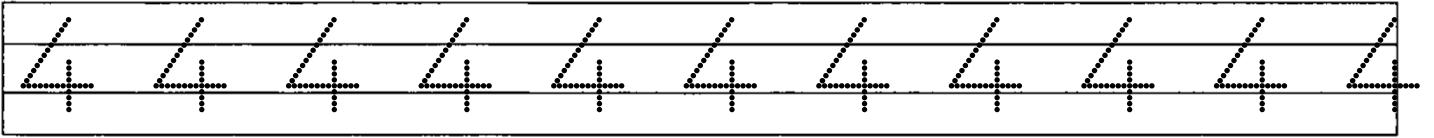
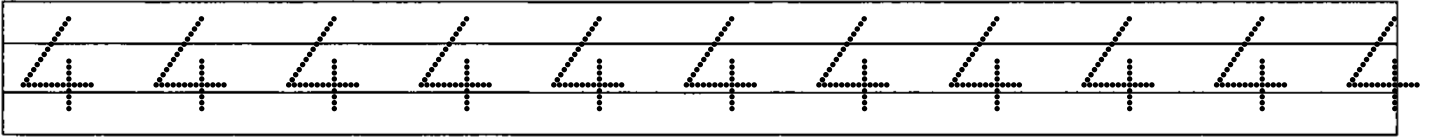
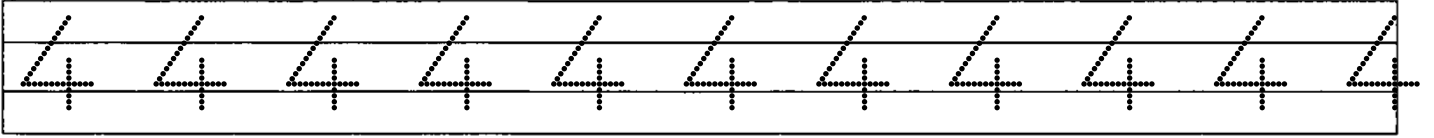
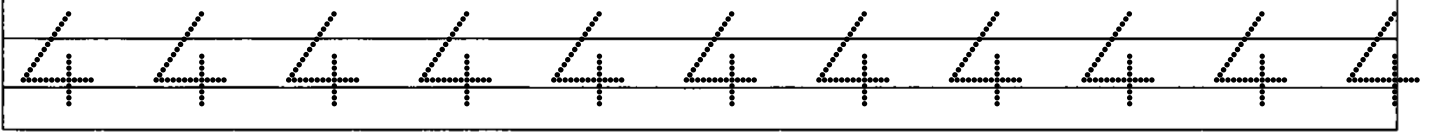
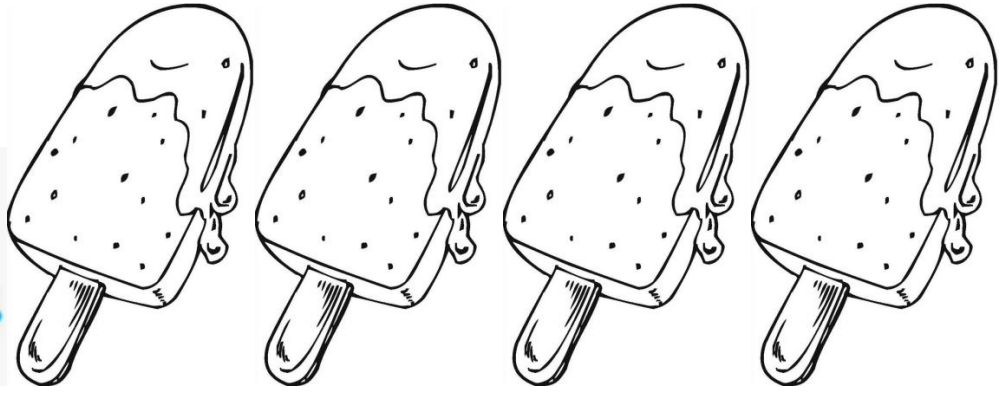

➔ Üzerinden gidelim, tamamlayalım.

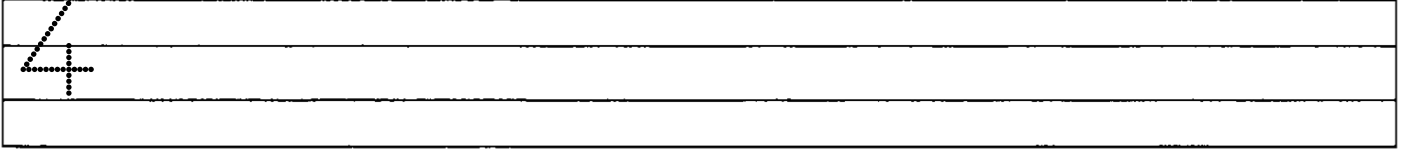
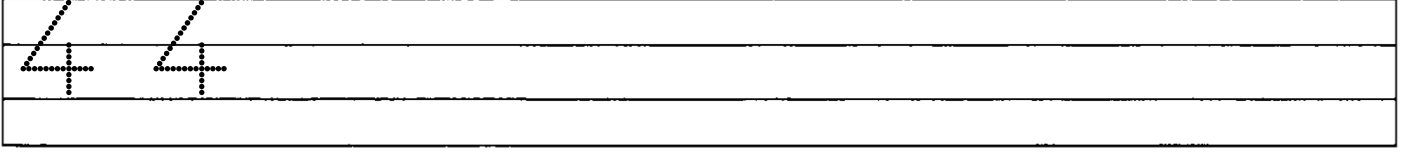
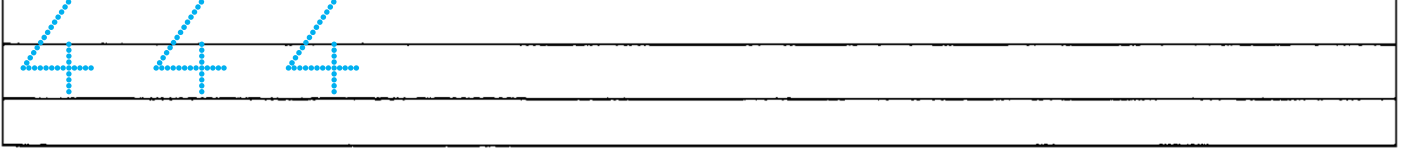

➔ Aşağıdaki varlıklardan 4' er tane olanları boyayalım.

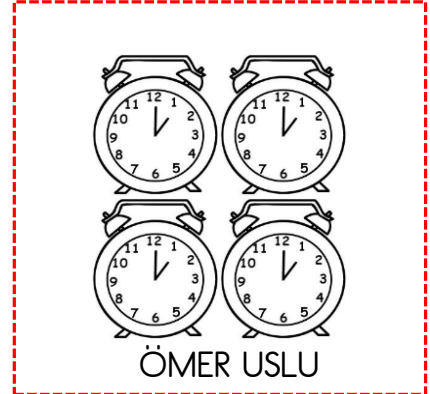
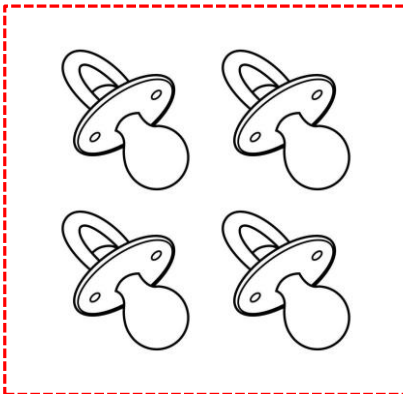
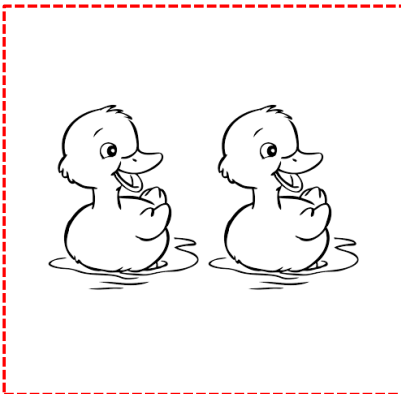
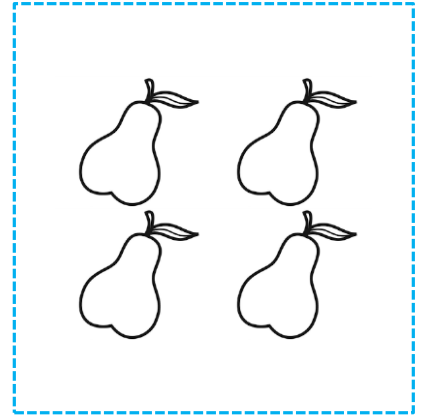
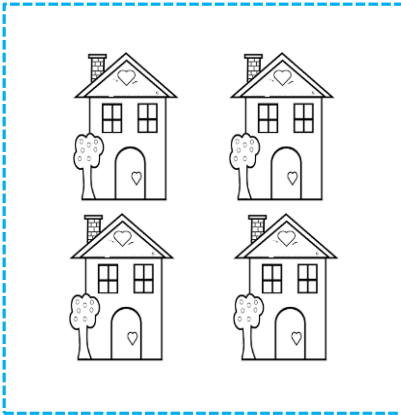
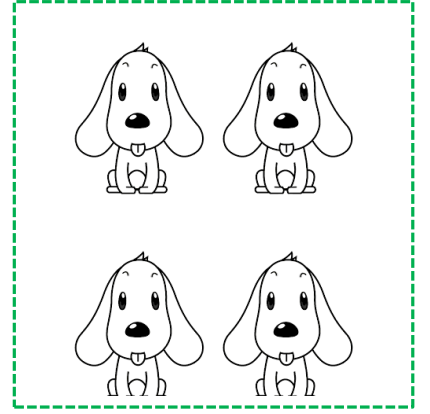
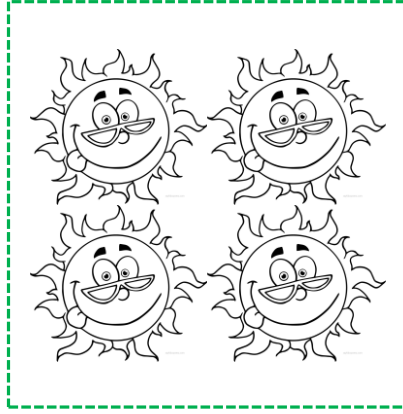
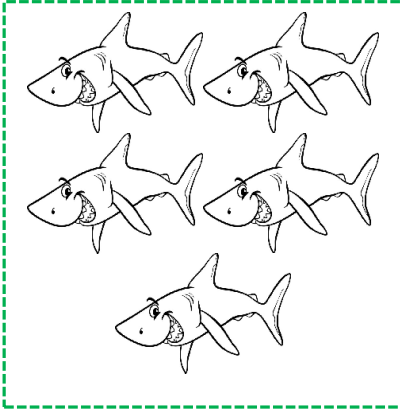

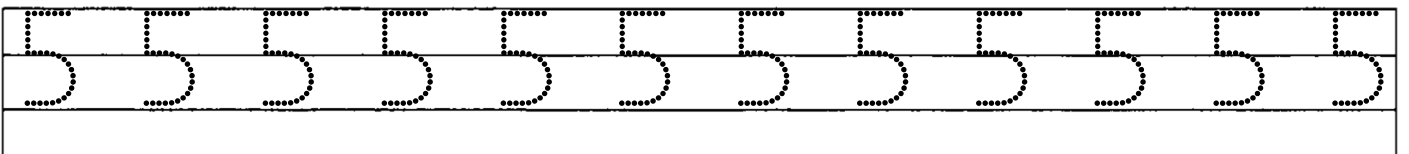
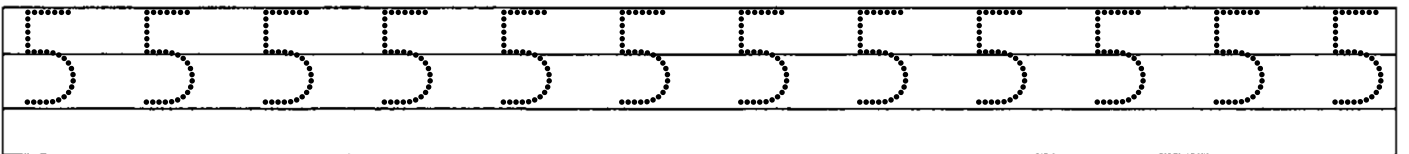
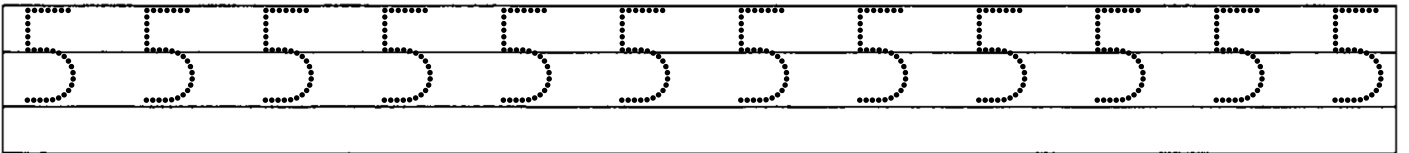
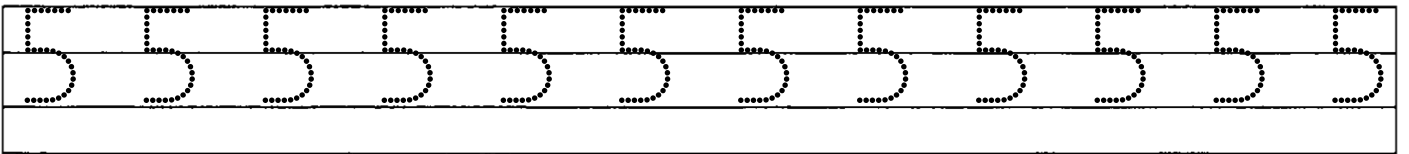
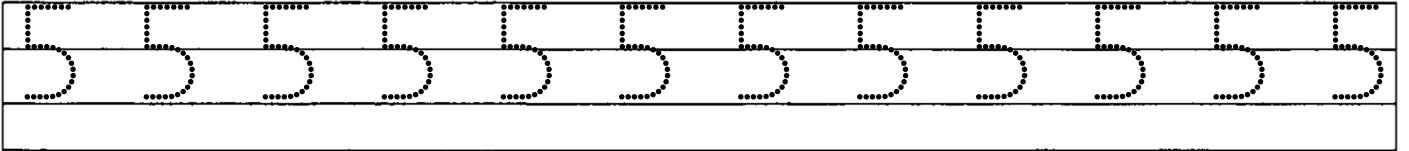
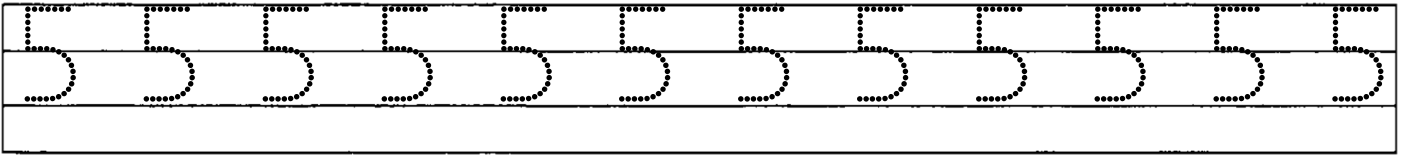
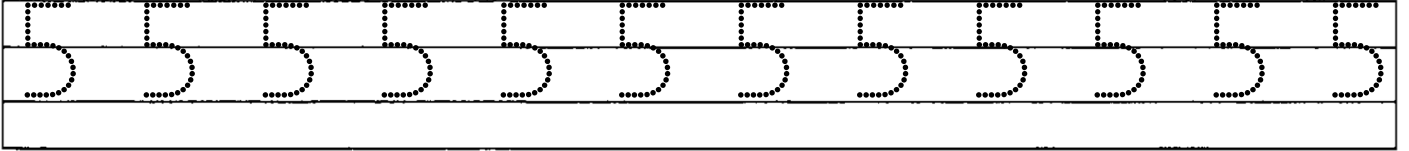
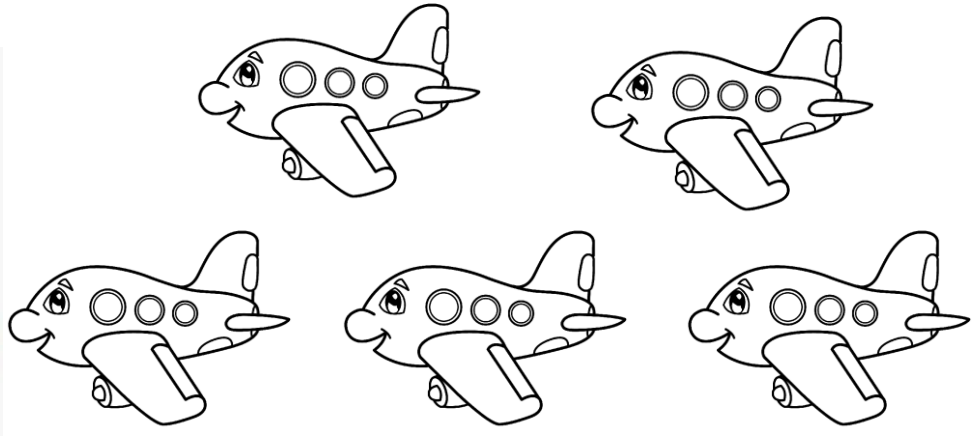
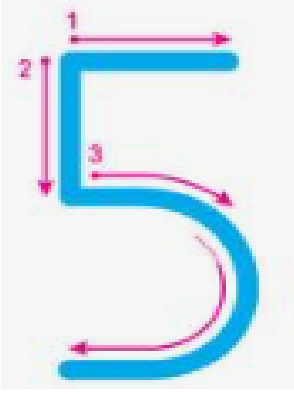

➔ Üzerinden gidelim, tamamlayalım.

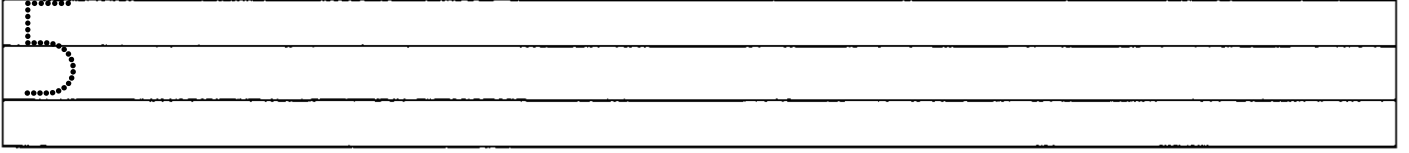
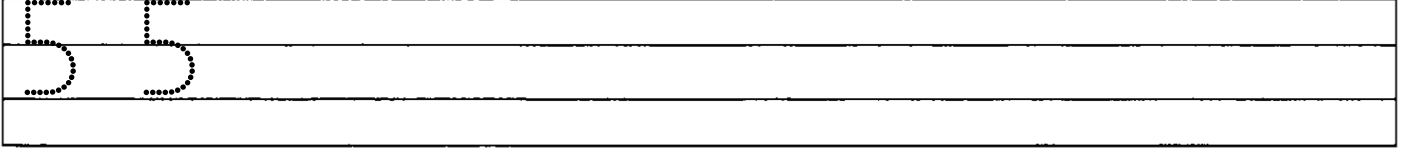
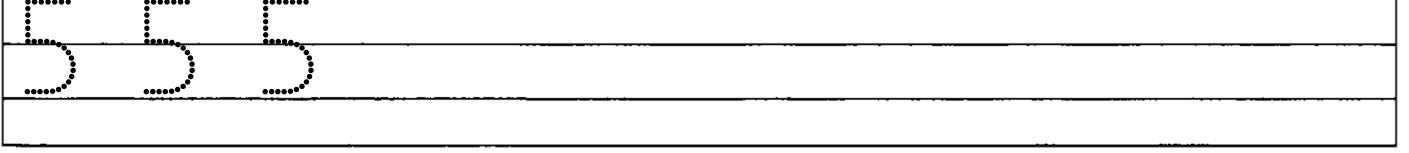

➔ Aşağıdaki varlıklardan 5' er tane olanları boyayalım.

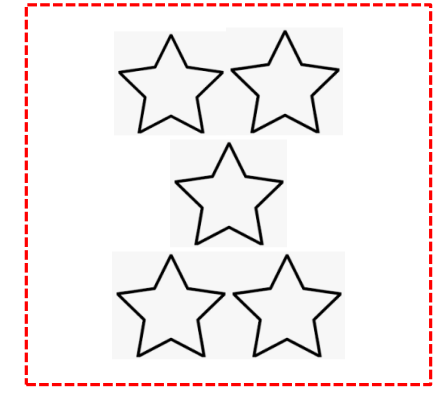
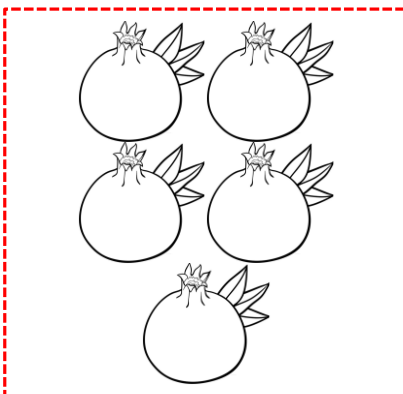
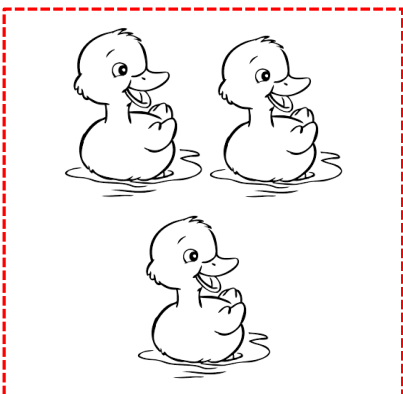
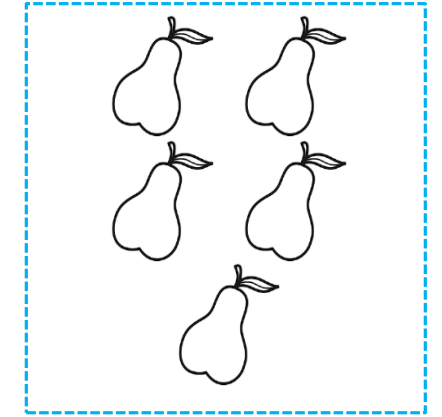
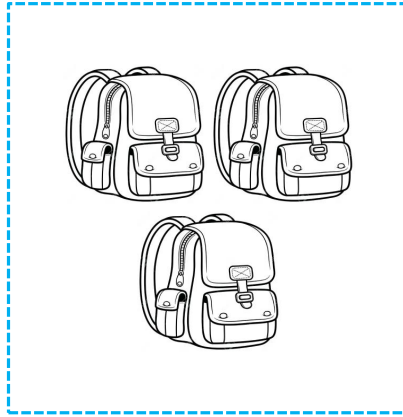
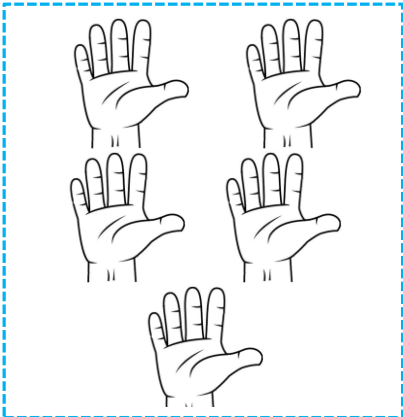
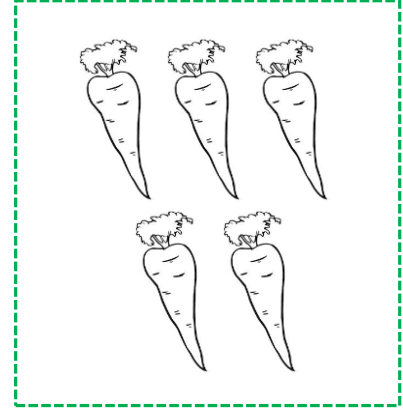
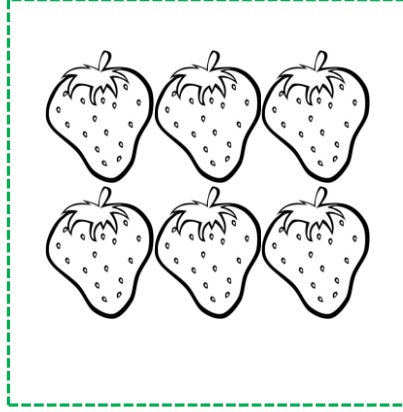
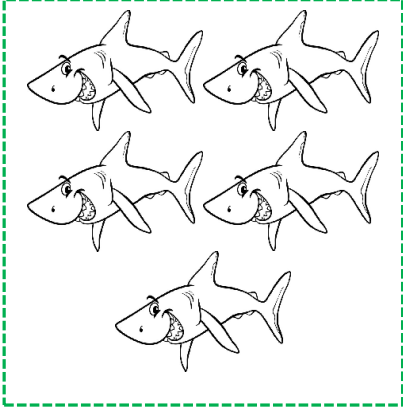

Boyayalım.

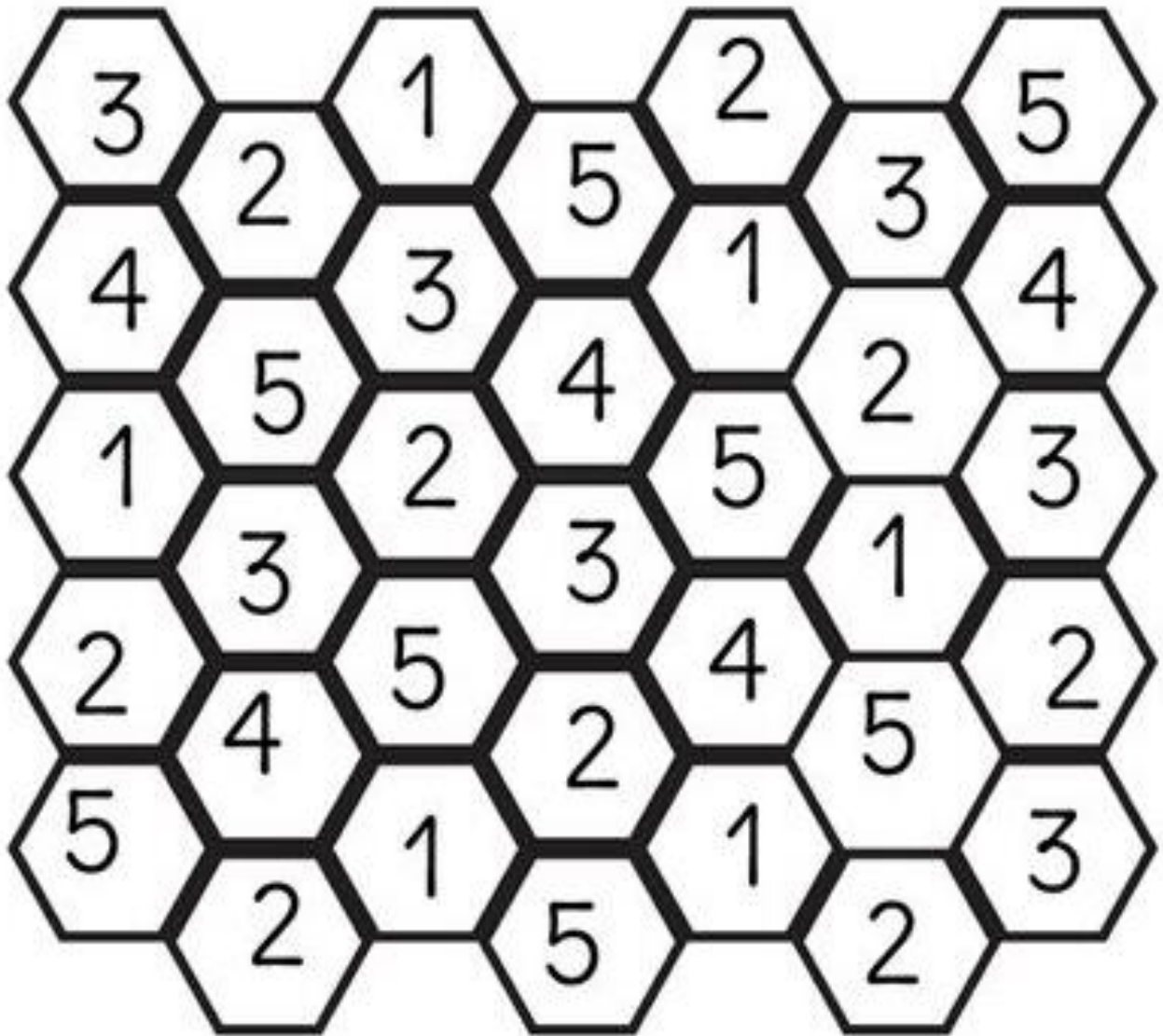

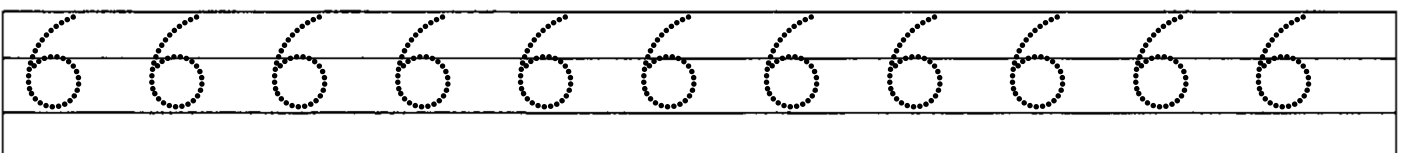
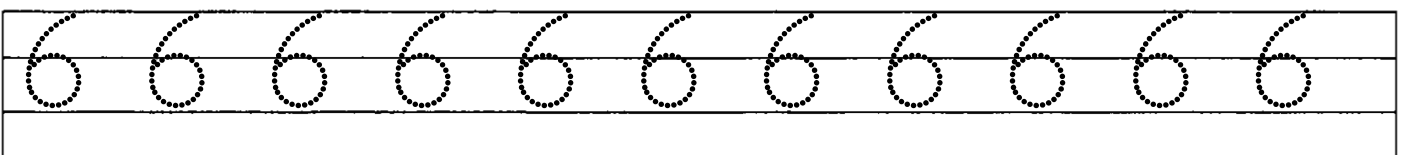
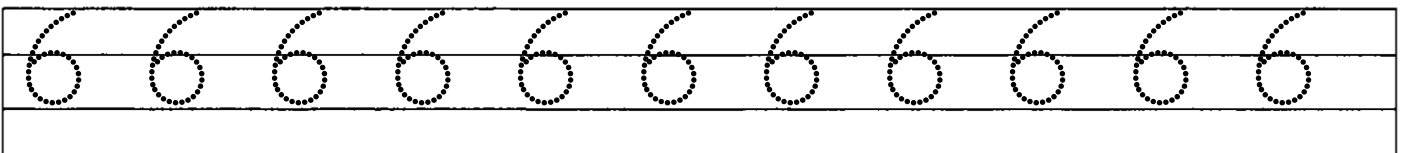
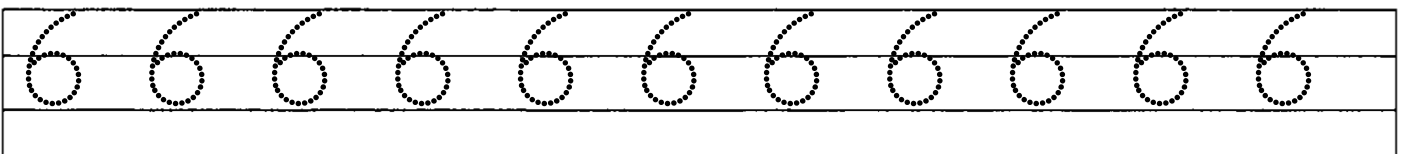
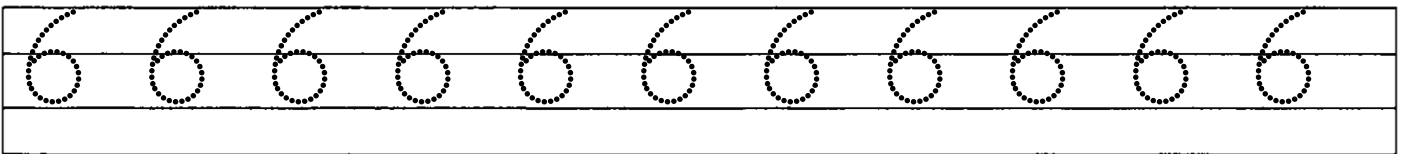
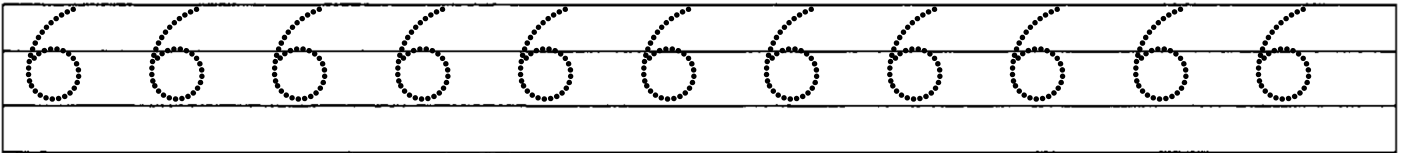
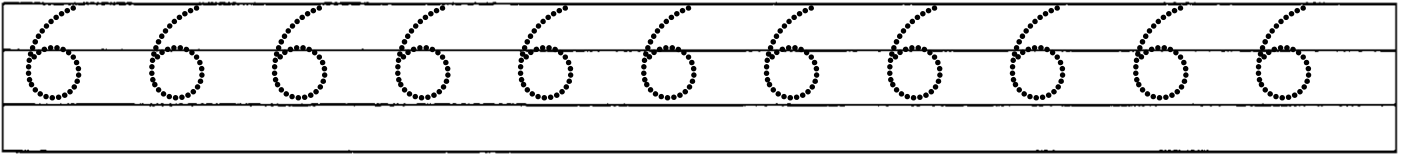
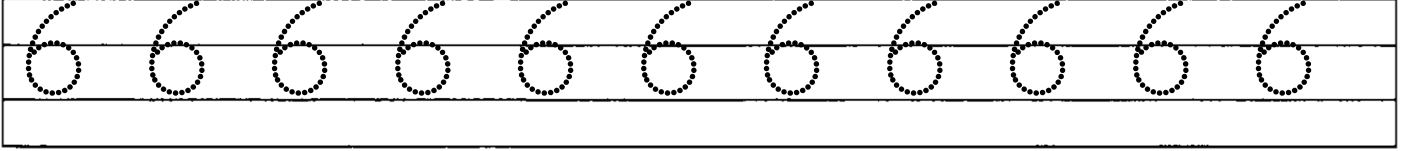
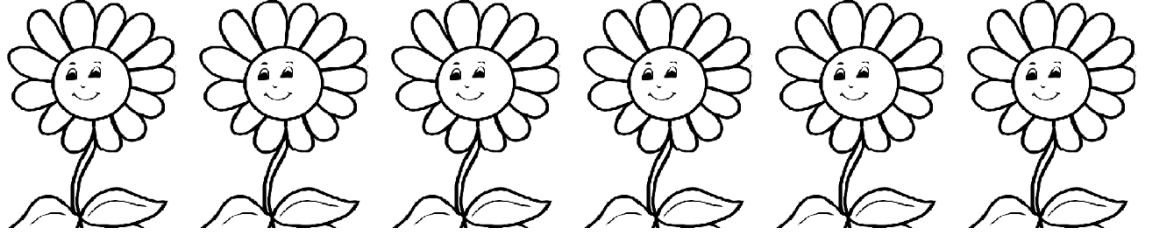
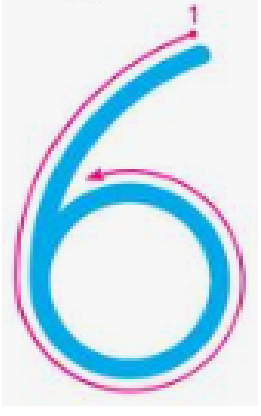



➔ Üzerinden gidelim, tamamlayalım.

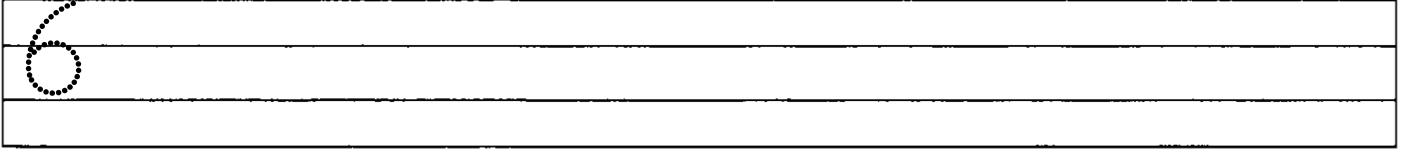
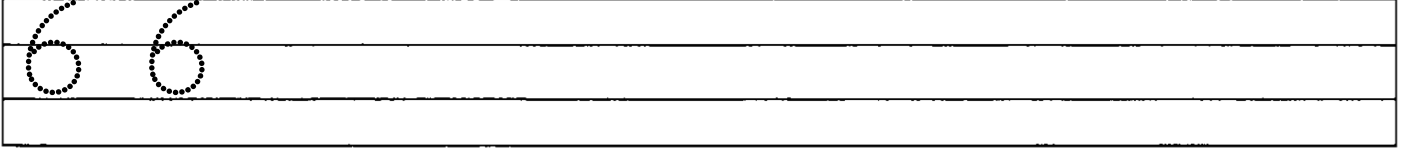
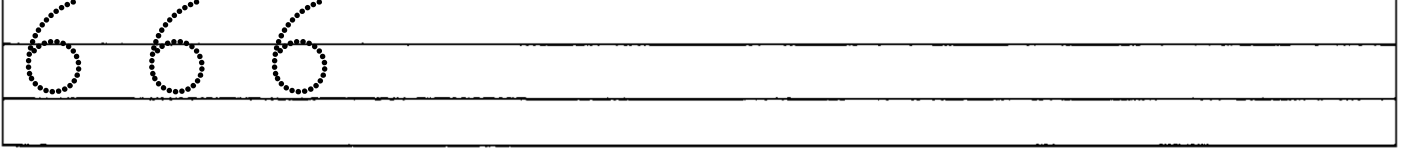

➔ Aşağıdaki varlıklardan 6' şar tane olanları boyayalım.

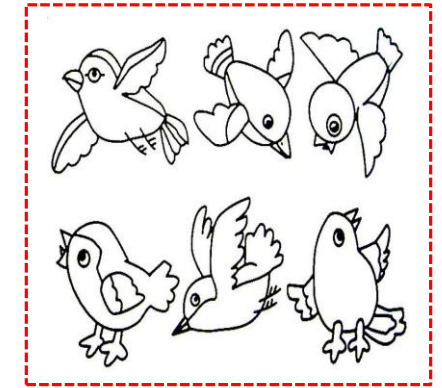
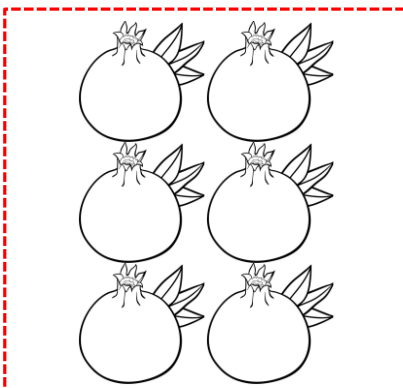
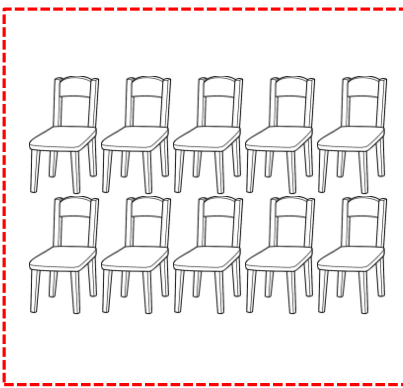
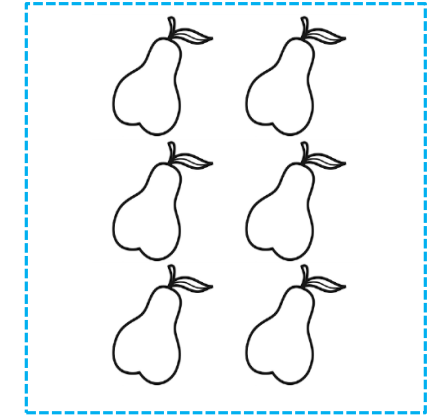
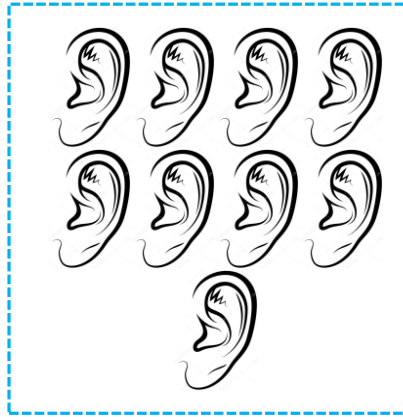
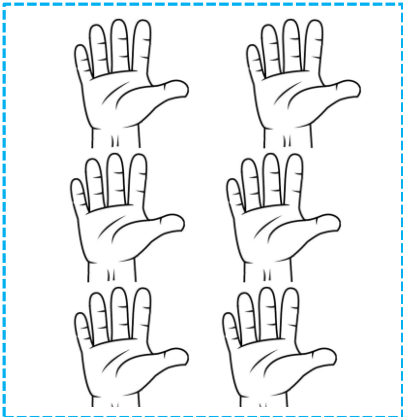
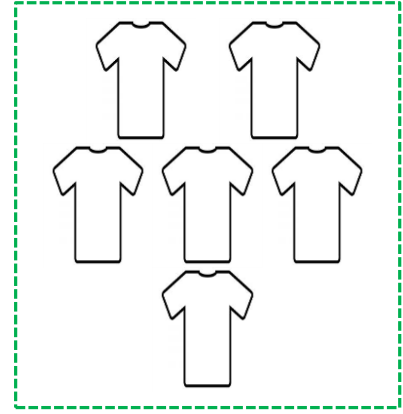
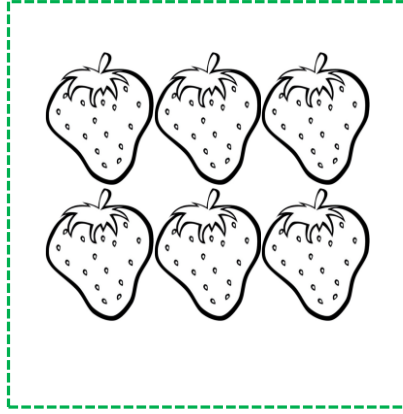
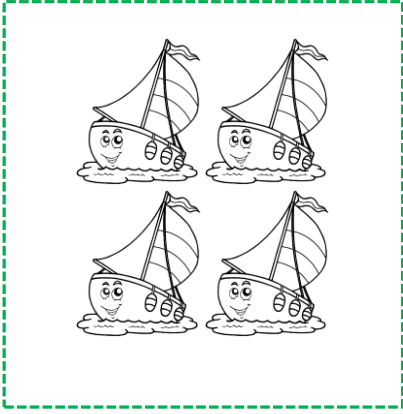

# Boyayalım



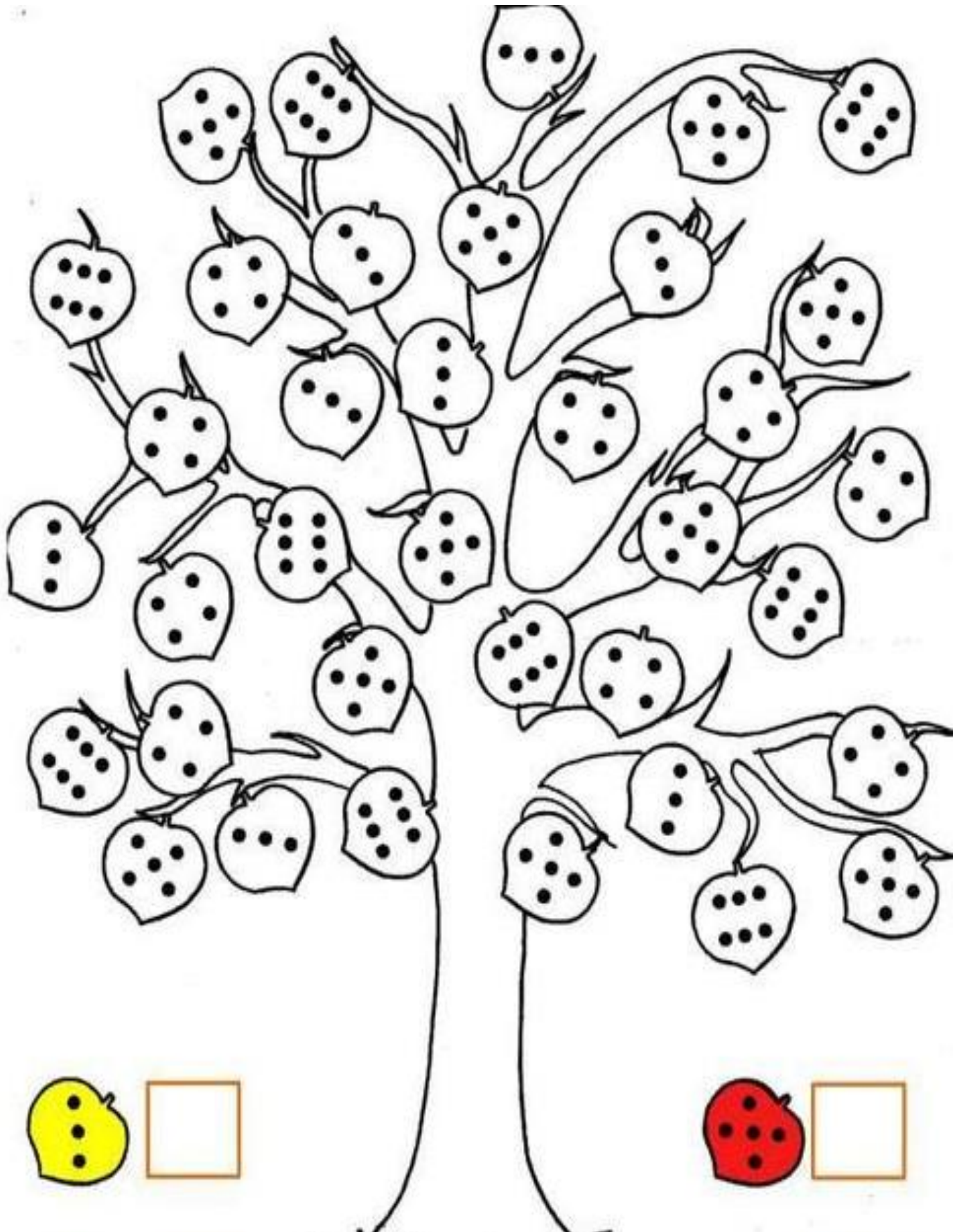

Strawberry



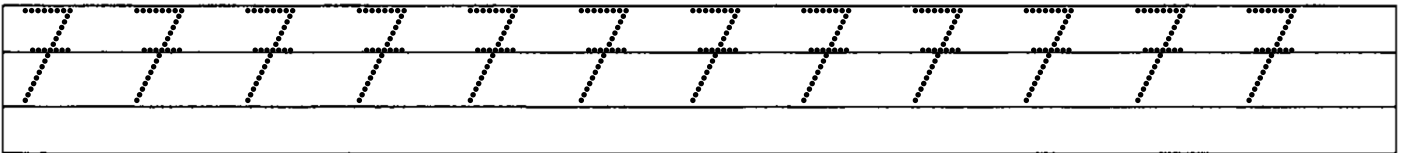
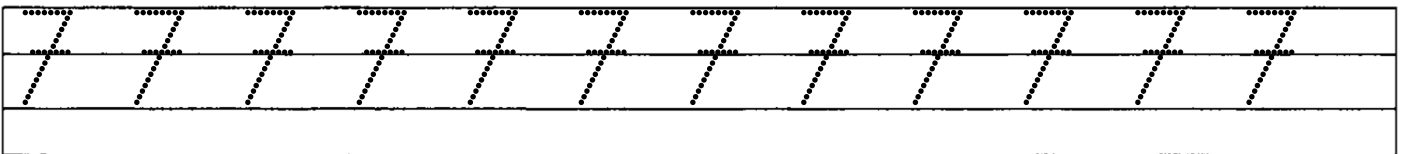
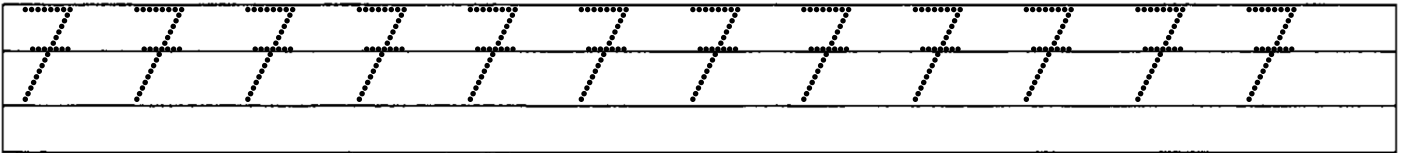
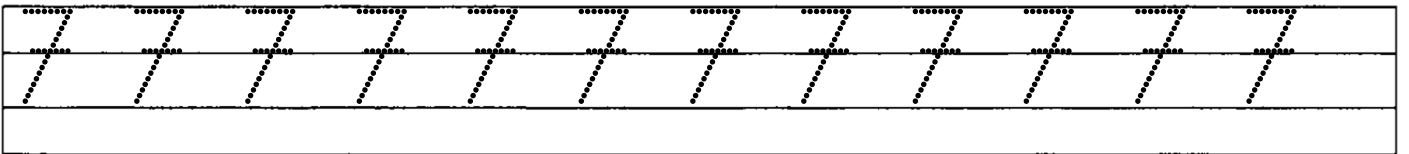
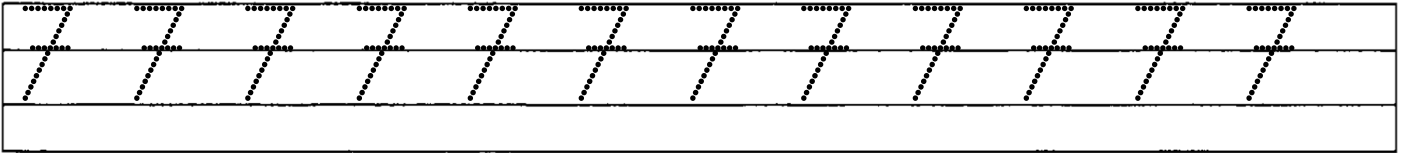
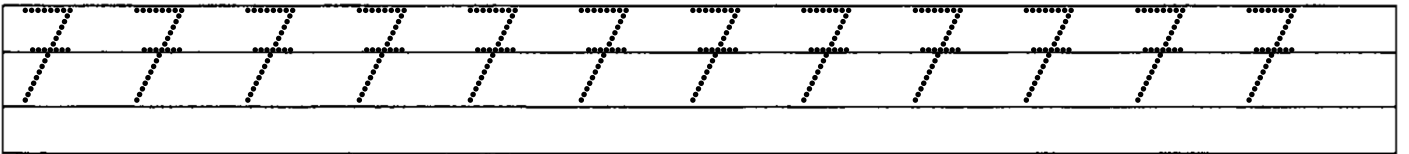
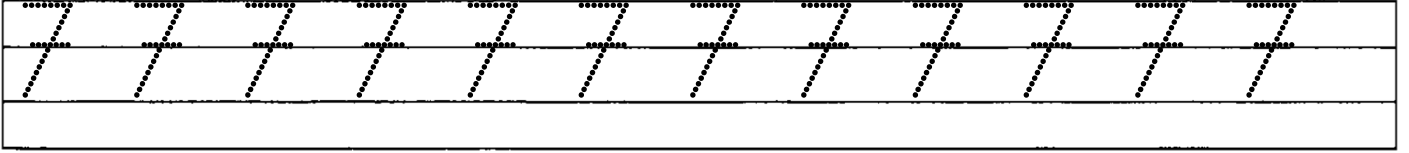
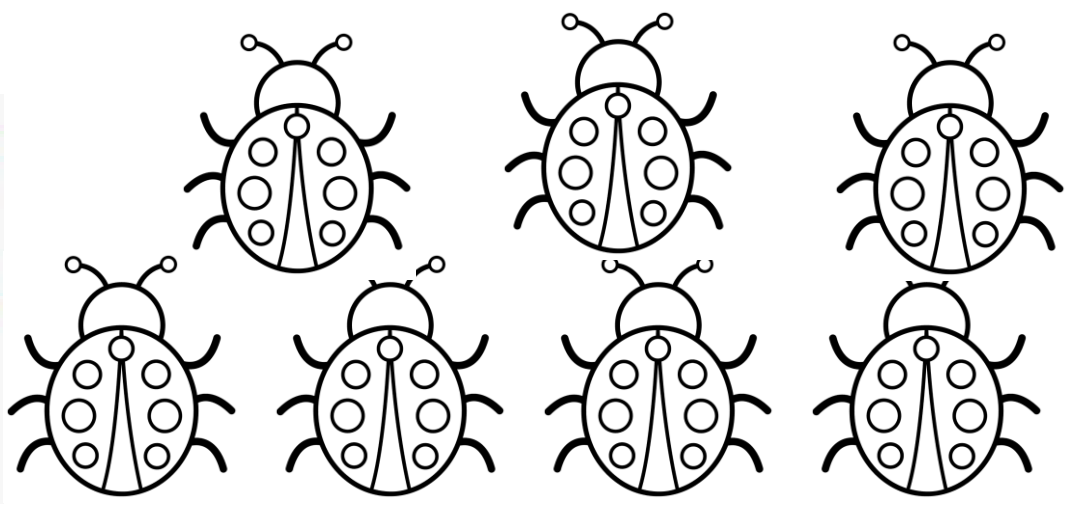
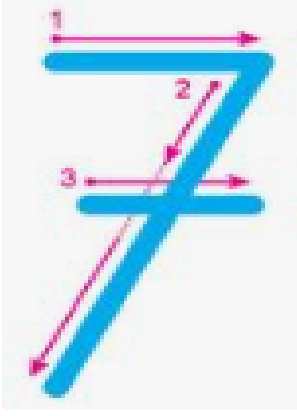

➔ Üzerinden gidelim, tamamlayalım.

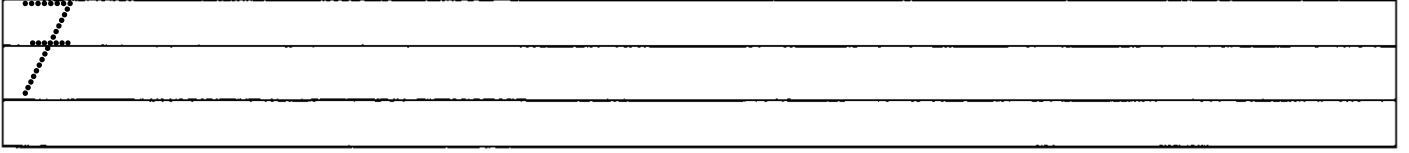
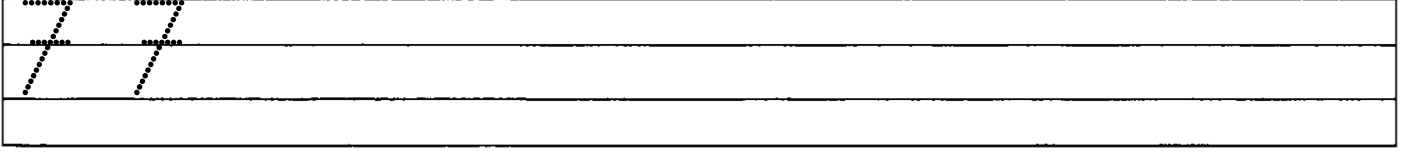
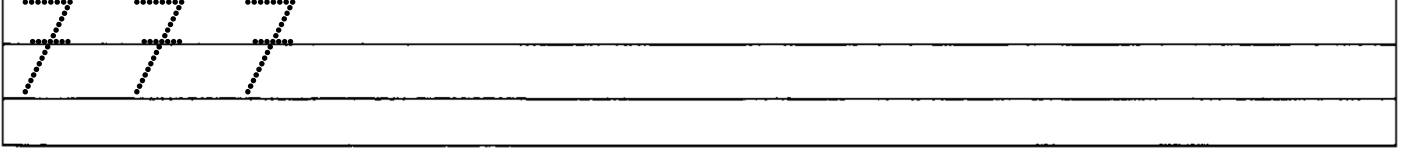

➔ Aşağıdaki varlıklardan 7' şer tane olanları boyayalım.

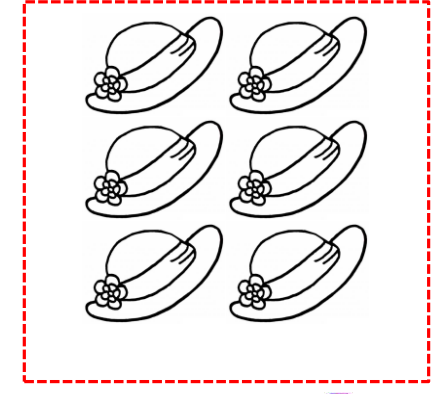
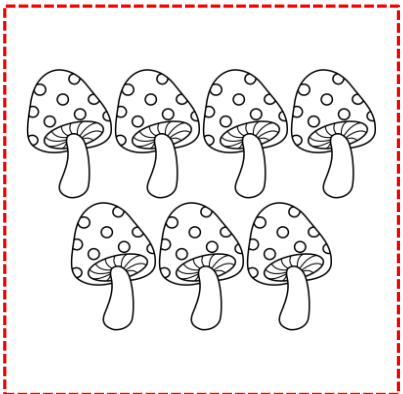
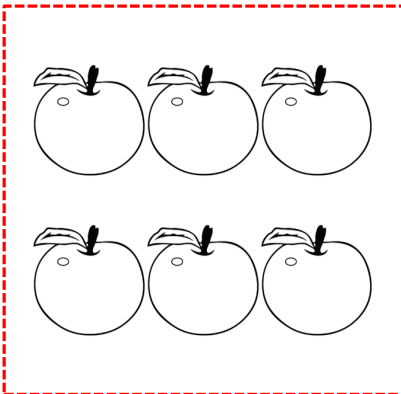
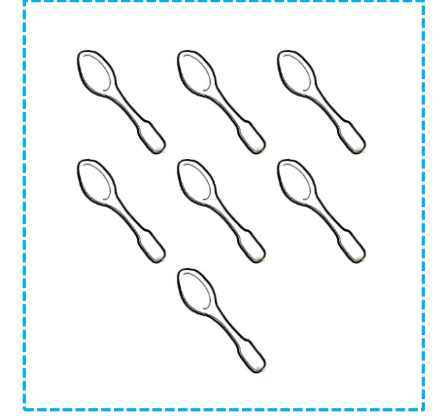
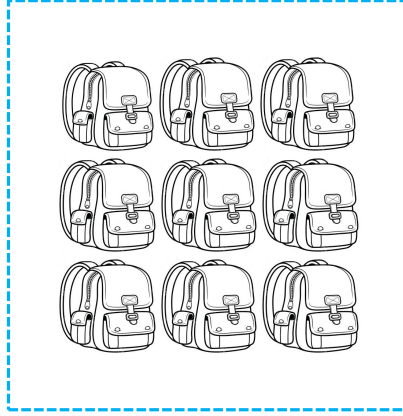
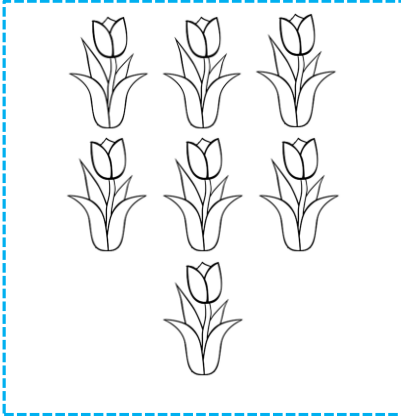
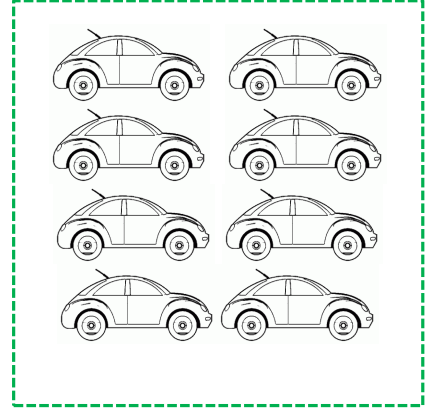
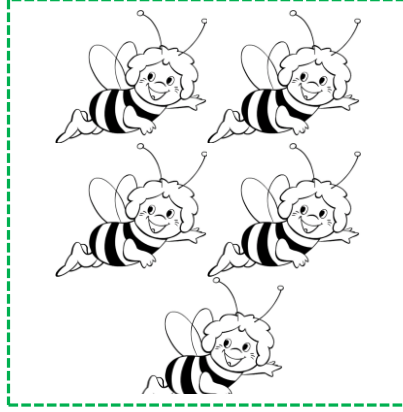
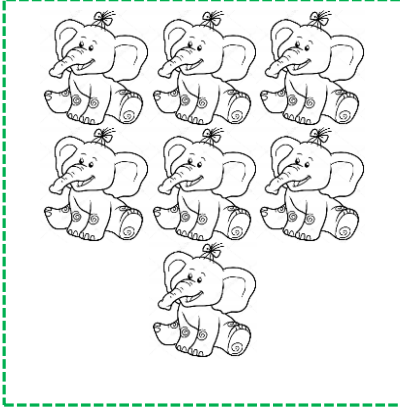

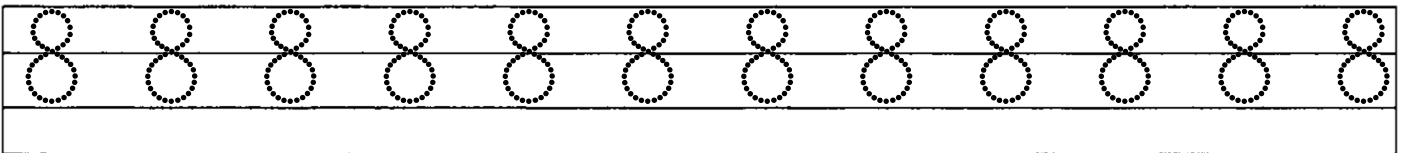
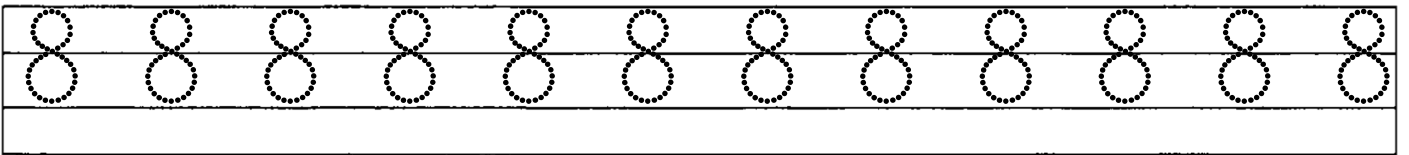
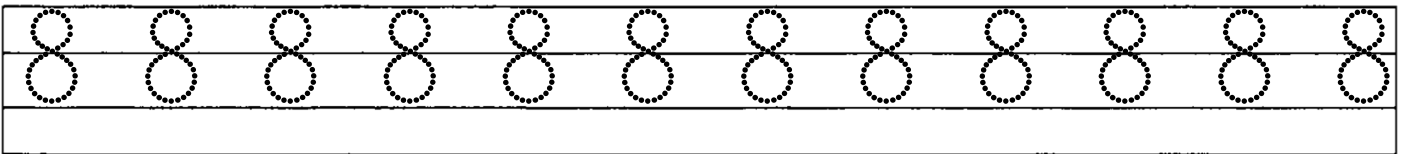
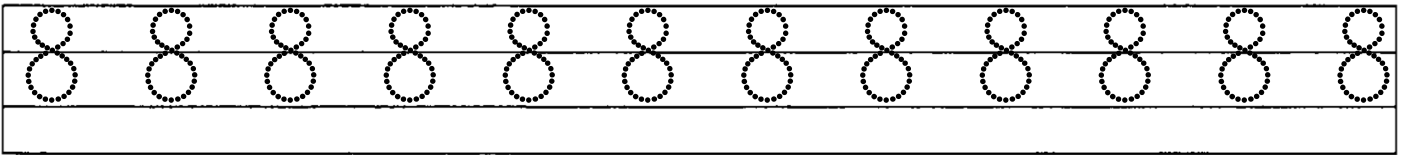
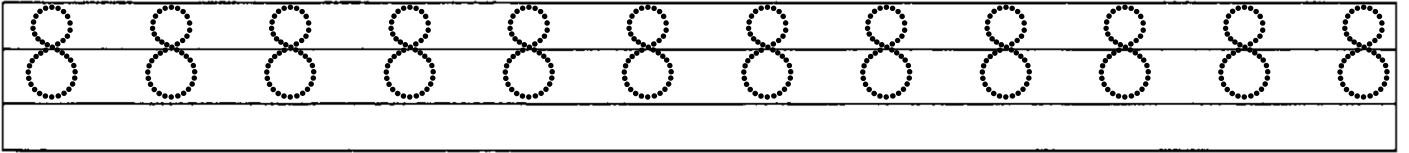
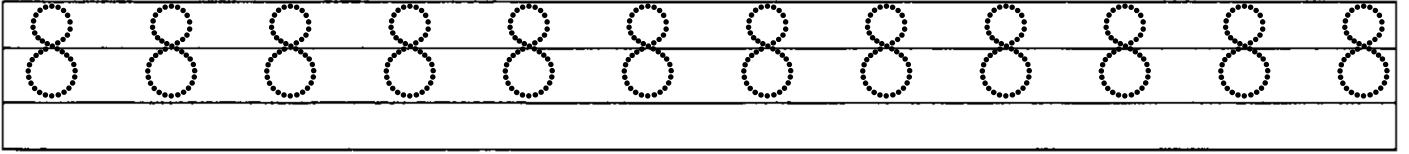
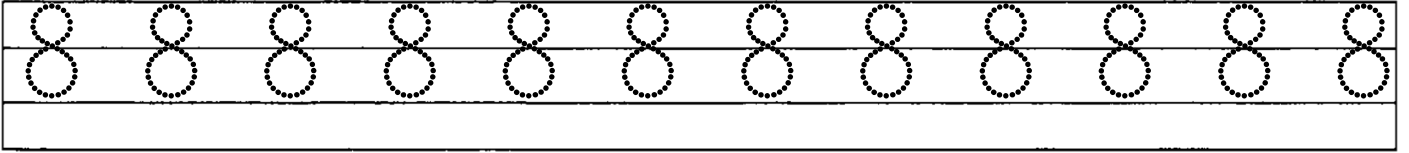
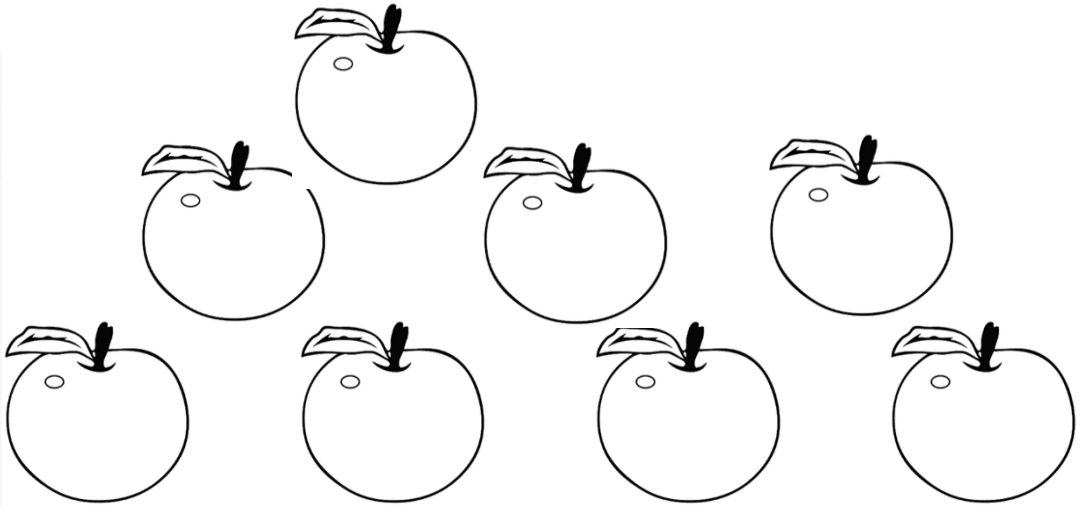
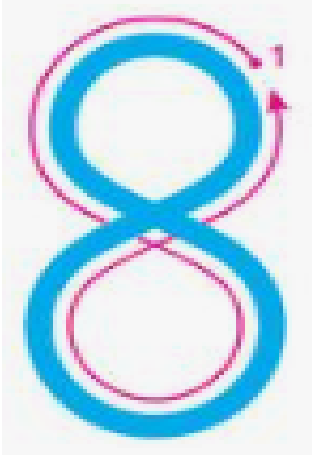

➔ Üzerinden gidelim, tamamlayalım.

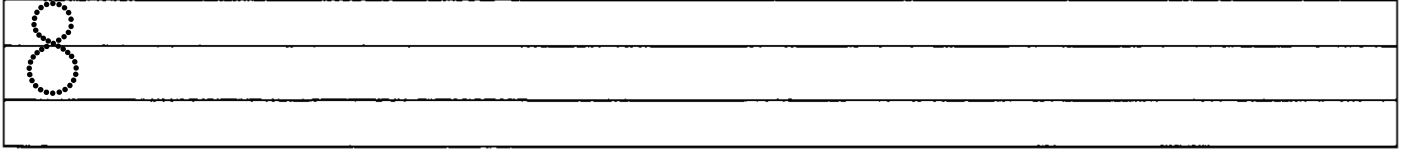
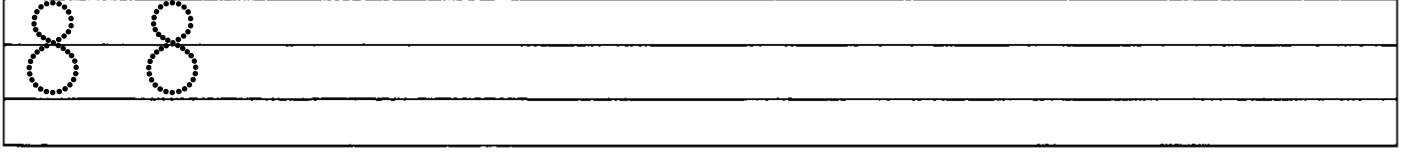
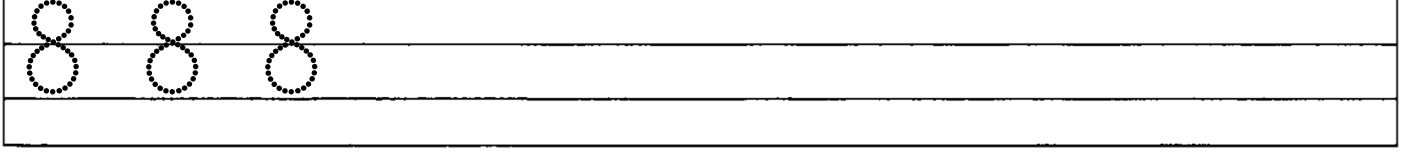

➔ Aşağıdaki varlıklardan 8' er tane olanları boyayalım.

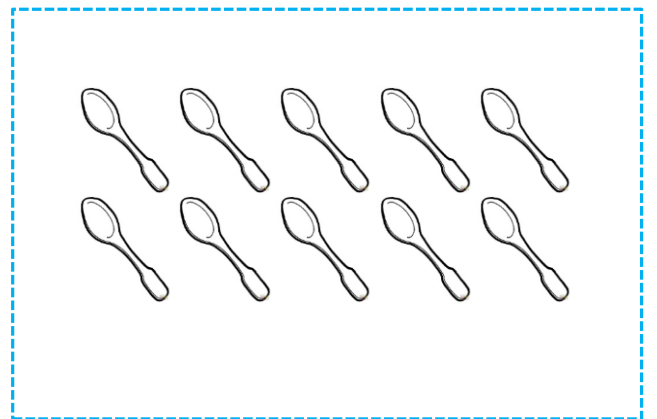
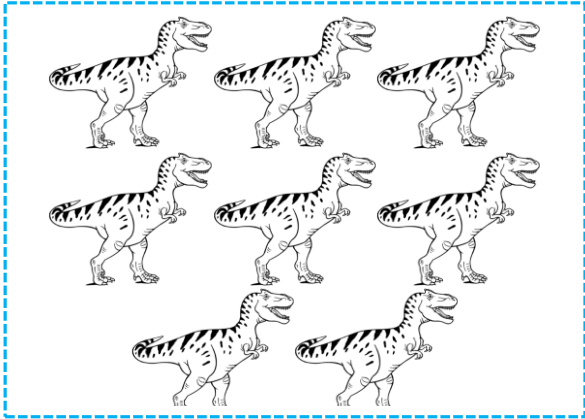
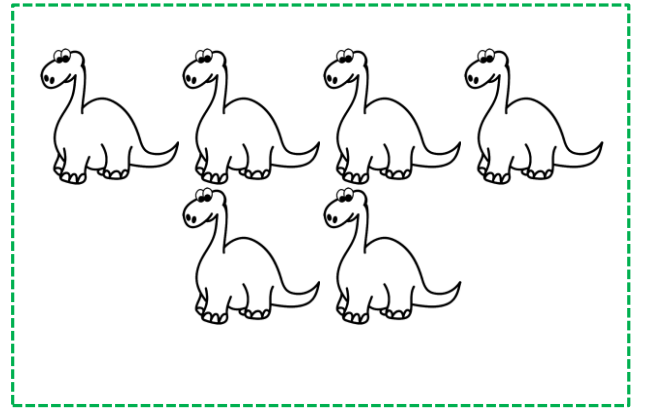
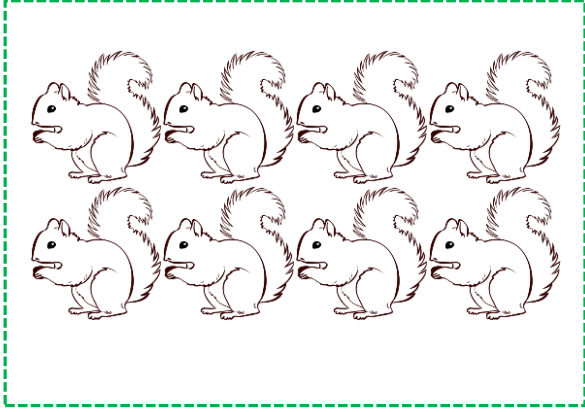

Ömer USLU

omeruslu06etkinlikleri 

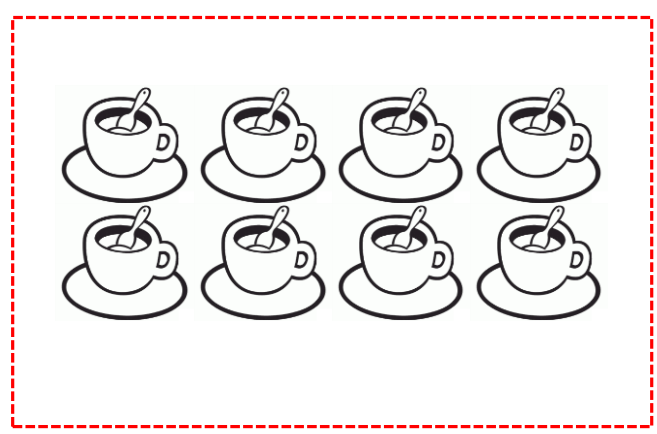
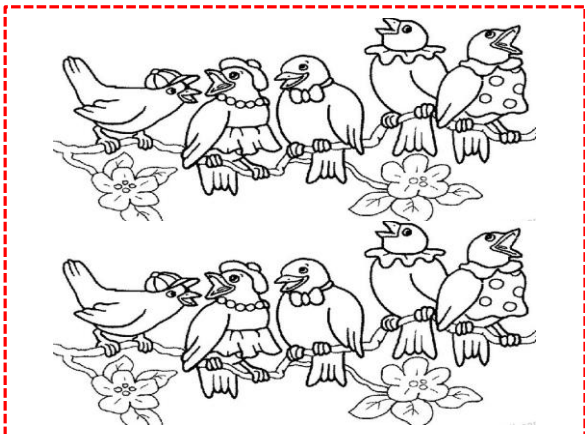

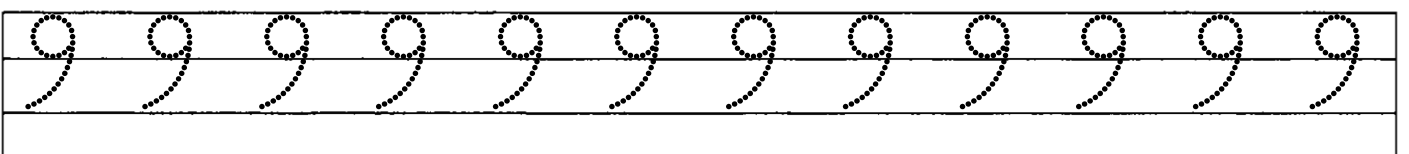
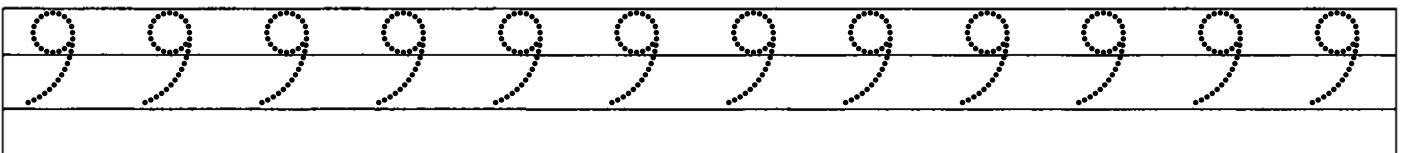
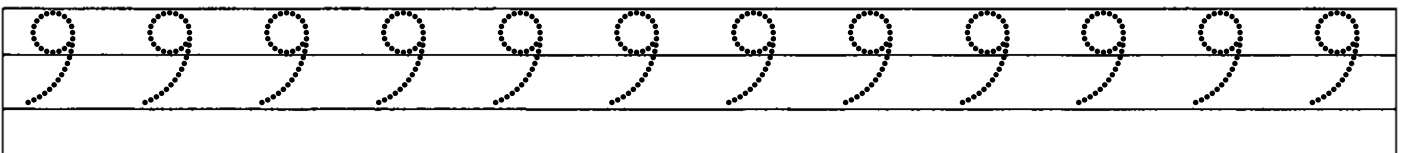
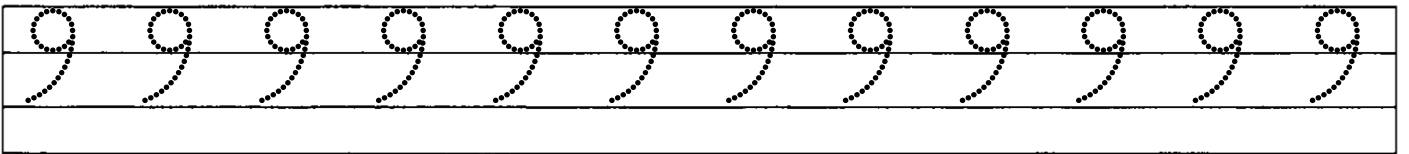
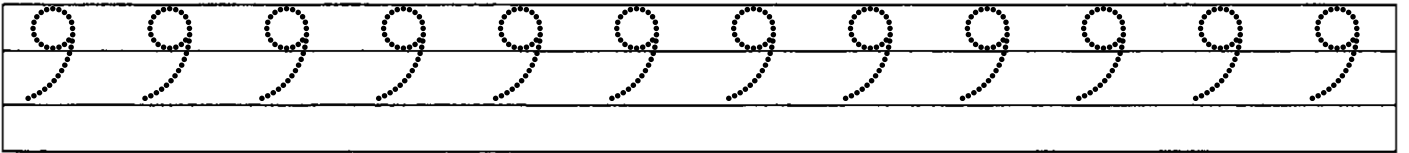
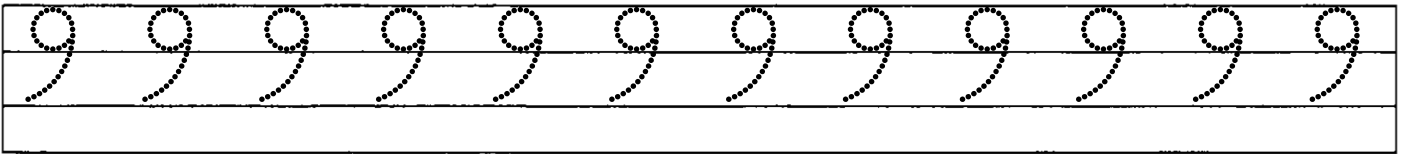
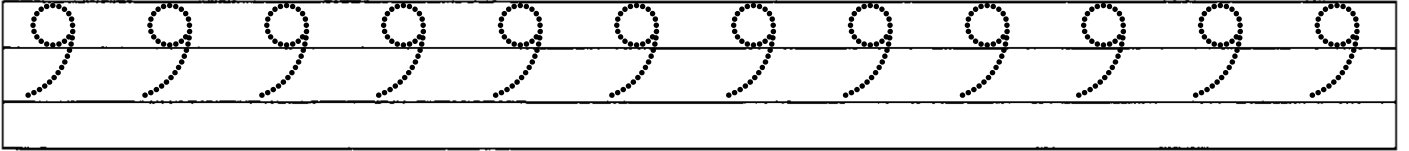
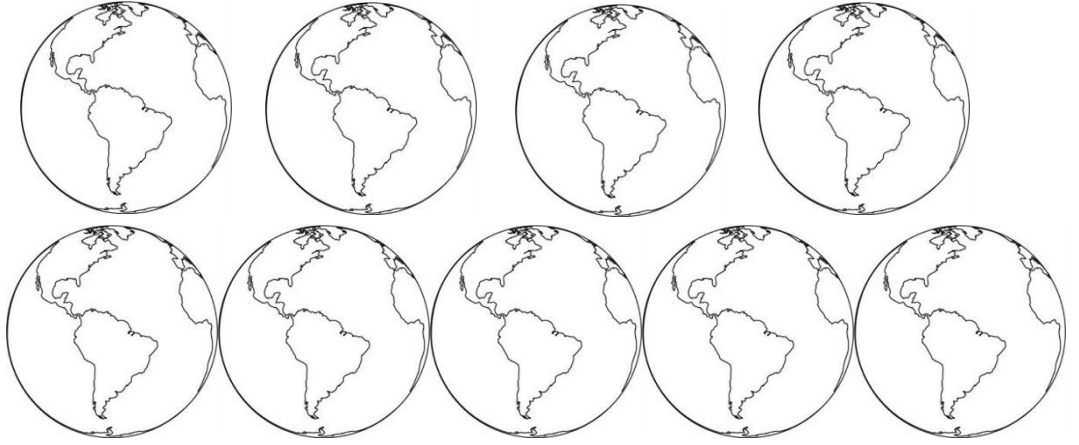
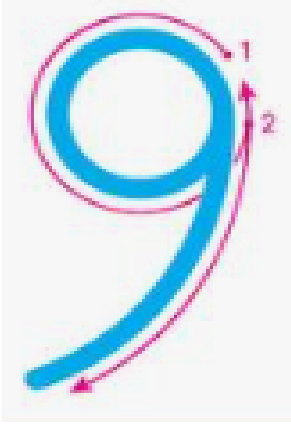



➔ Üzerinden gidelim, tamamlayalım.

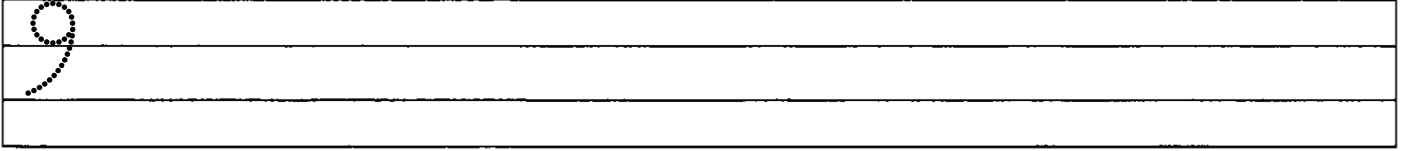
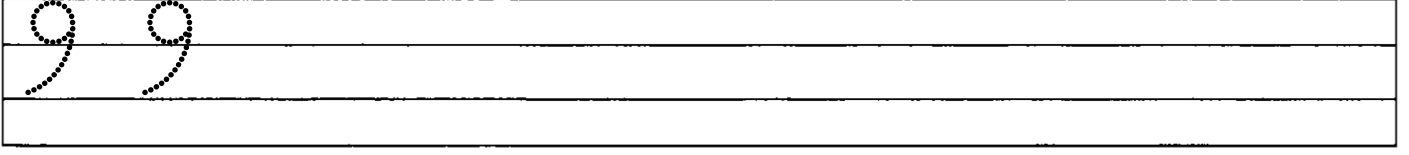
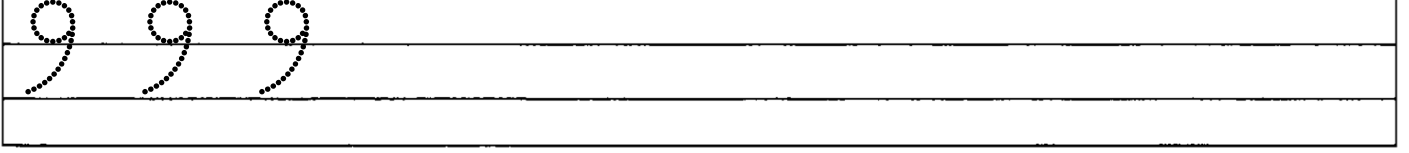

➔ Aşağıdaki varlıklardan 9' ar tane olanları boyayalım.

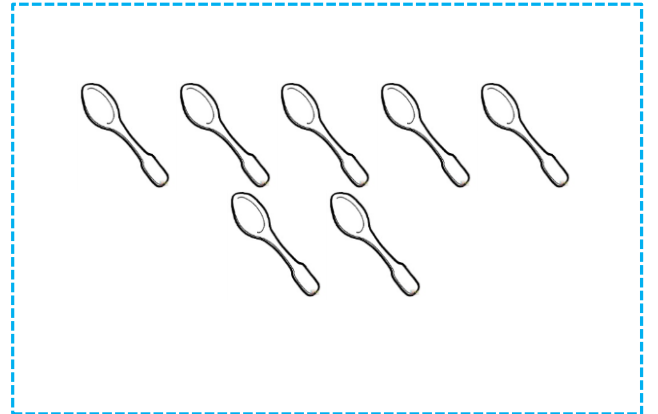
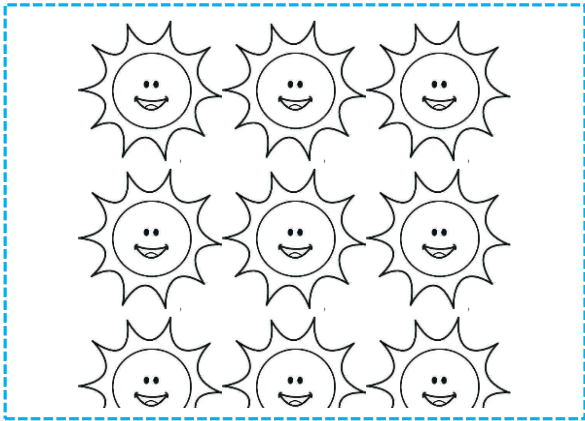
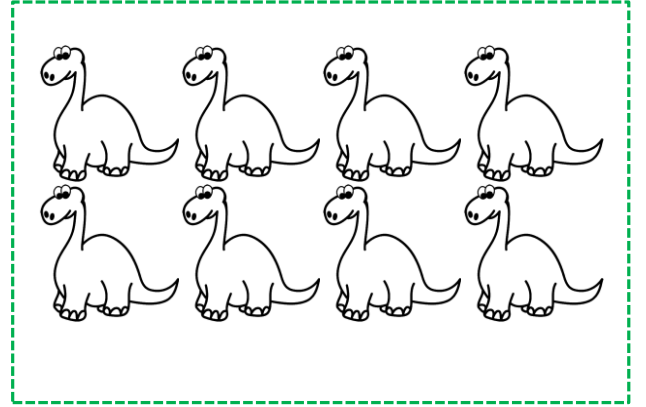
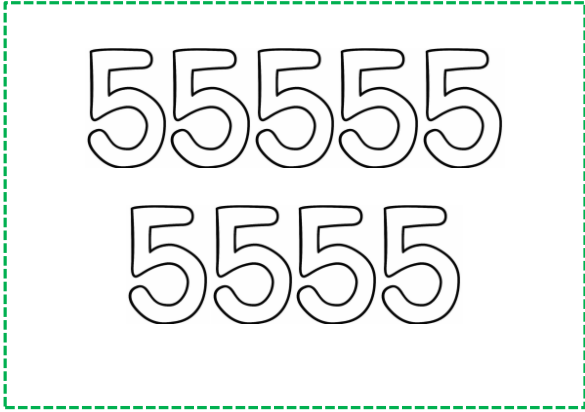

Ömer USLU

omeruslu06etkinlikleri 

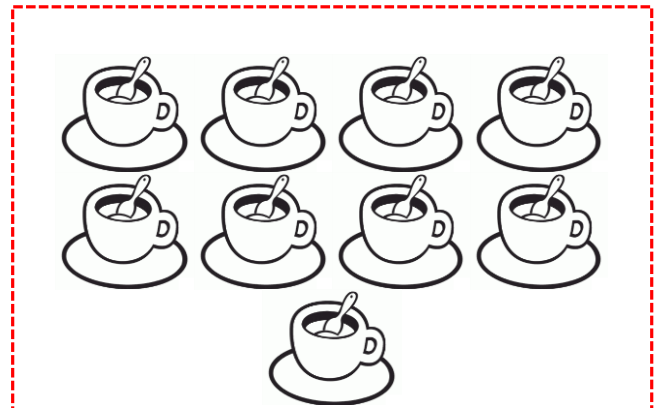
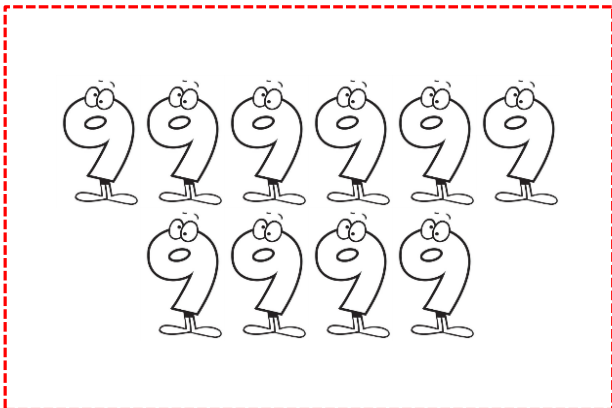

# Boyayalım

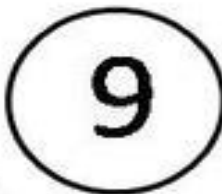
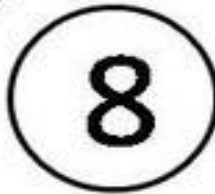
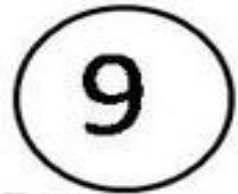
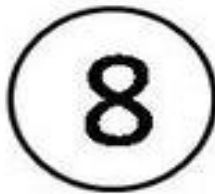

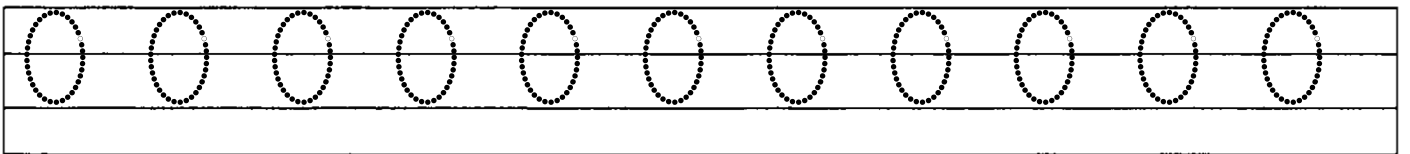
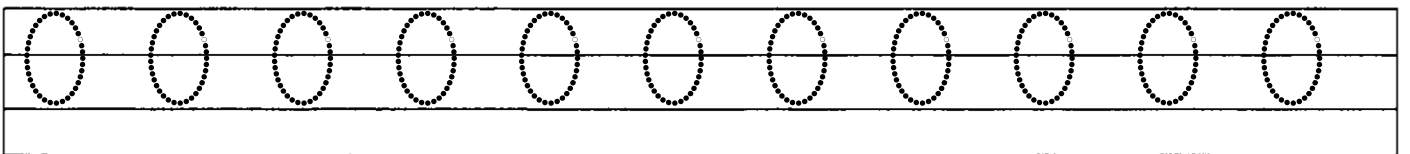
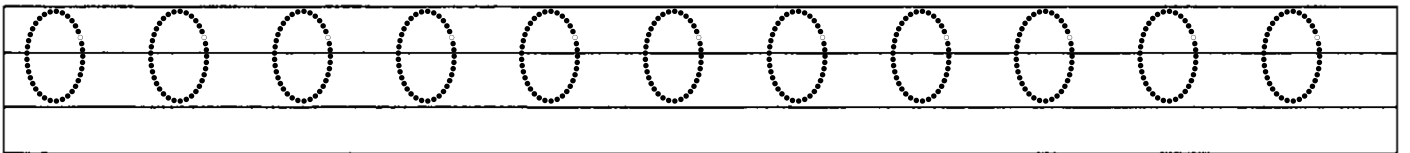
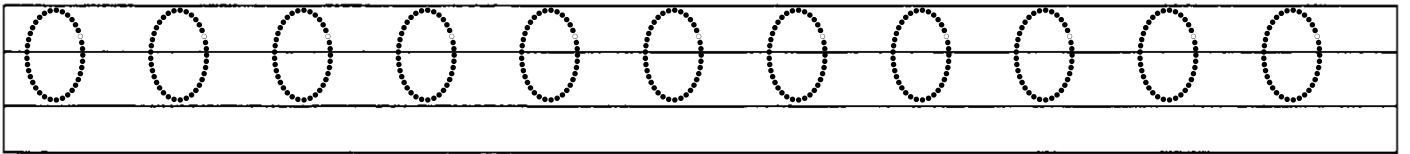
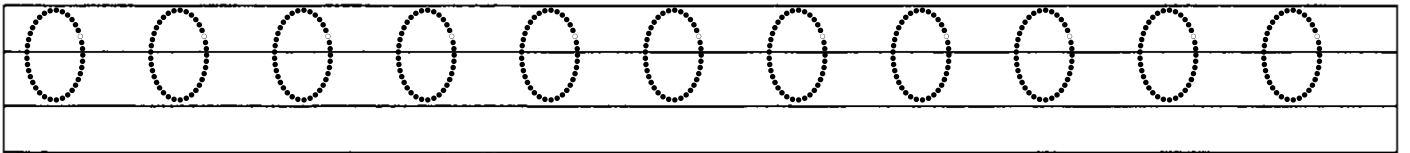
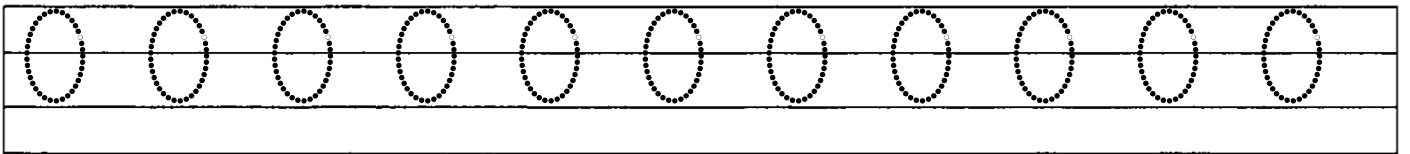
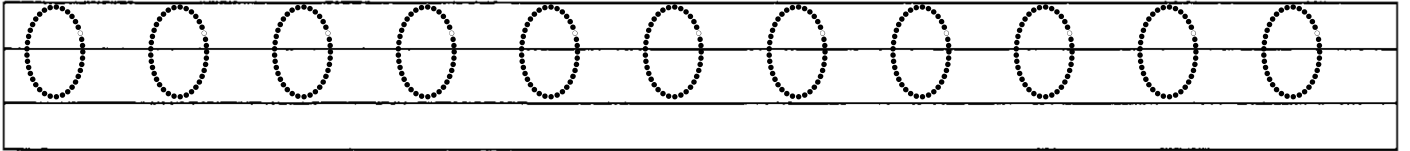
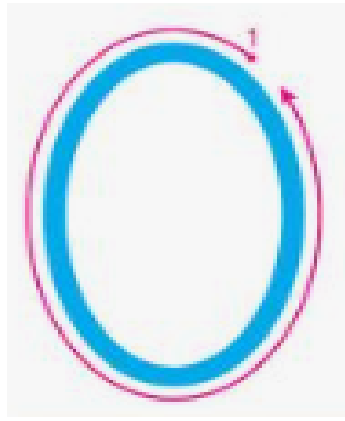

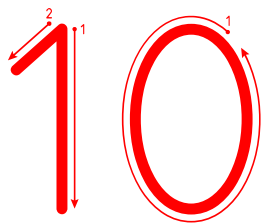
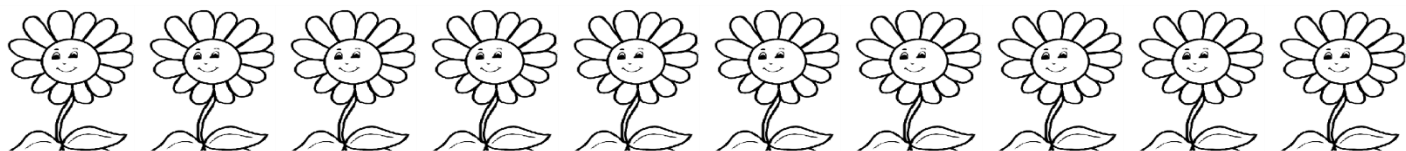

10 10 10 10 10 10 10 10

10 10 10 10 10 10 10 10

10 10 10 10 10 10 10 10

10 10 10 10 10 10 10 10

10 10 10 10 10 10 10 10

10 10 10 10 10 10 10 10

10 10 10 10 10 10 10 10

10 10 10 10 10 10 10 10

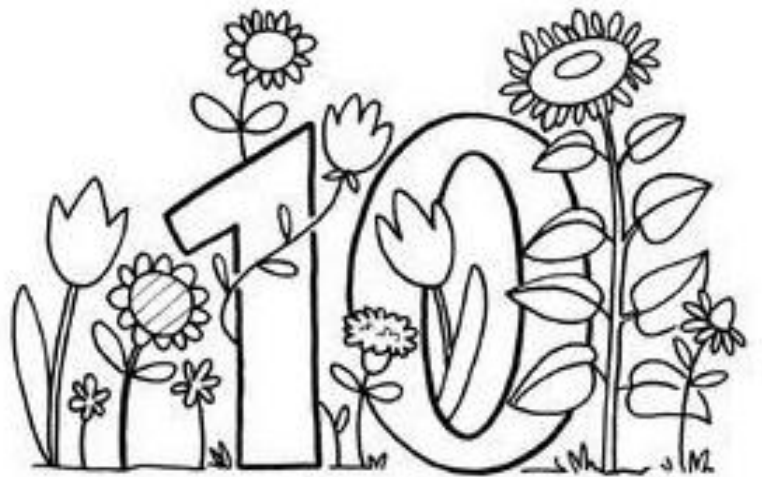
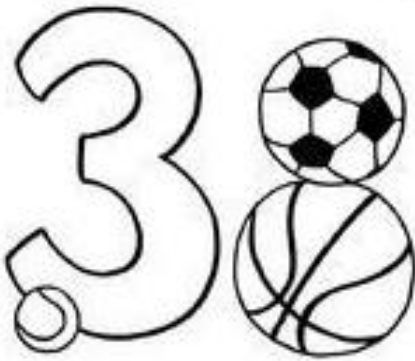

Boyayalım.

